

Deep Learning of Representations

AAAI Tutorial

Yoshua Bengio

July 14th 2013, Bellevue, WA, USA

Université 
de Montréal



Outline of the Tutorial

1. Motivations and Scope
2. Algorithms
3. Practical Considerations
4. Challenges

See (Bengio, Courville & Vincent 2013)

“Unsupervised Feature Learning and Deep Learning: A Review and New Perspectives” and <http://www.iro.umontreal.ca/~bengioy/talks/deep-learning-tutorial-aaai2013.html> for a pdf of the slides and a detailed list of references.

Ultimate Goals

- **AI**
- Needs **knowledge**
- Needs **learning**
(involves priors + *optimization/search*)
- Needs **generalization**
(guessing where probability mass concentrates)
- Needs ways to fight the curse of dimensionality
(exponentially many configurations of the variables to consider)
- Needs disentangling the underlying explanatory factors
(making sense of the data)

Representation Learning

- Good **features** essential for successful ML

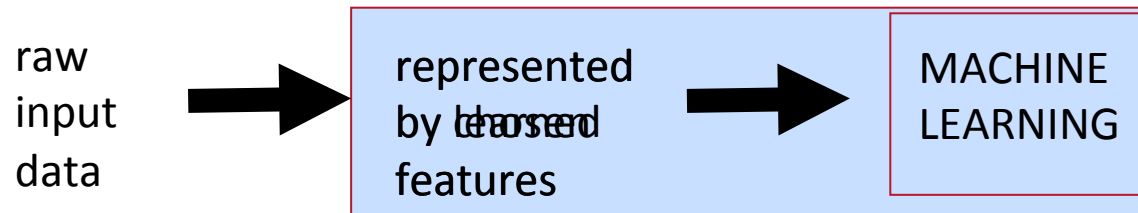

- Handcrafting features vs learning them
- Good representation: captures posterior belief about explanatory causes, disentangles these factors of variation
- Representation learning: **guesses** the features / factors / causes = good representation of observed data.

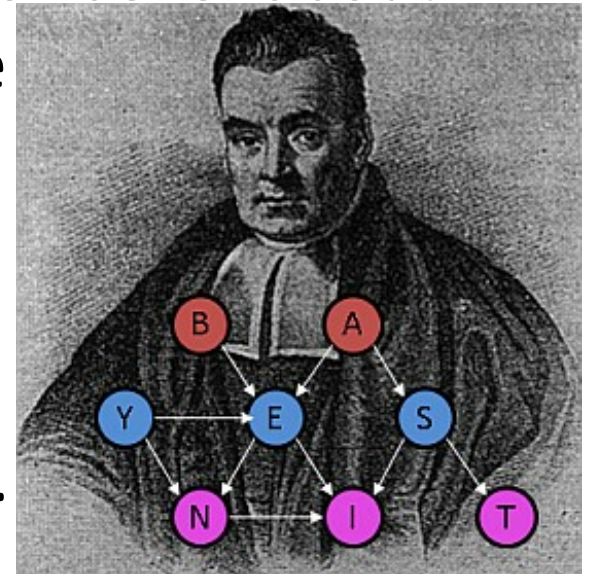

Deep Representation Learning

Learn multiple levels of representation of increasing complexity/abstraction

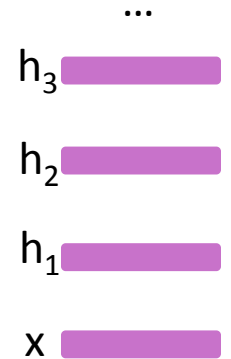

- potentially exponential gain in expressive power
- brains are deep
- humans organize knowledge in a compositional way
- **Better MCMC mixing in space of deeper representations**
(Bengio et al, ICML 2013)
- **They work! SOTA on industrial-scale AI tasks**
(object recognition, speech recognition, language modeling, music modeling)

Deep Learning

*When the number of levels can be data-selected, this is a **deep architecture***

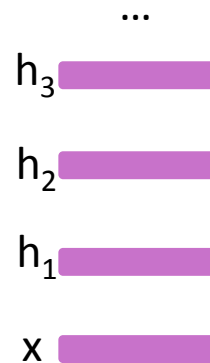

A Good Old Deep Architecture: MLPs

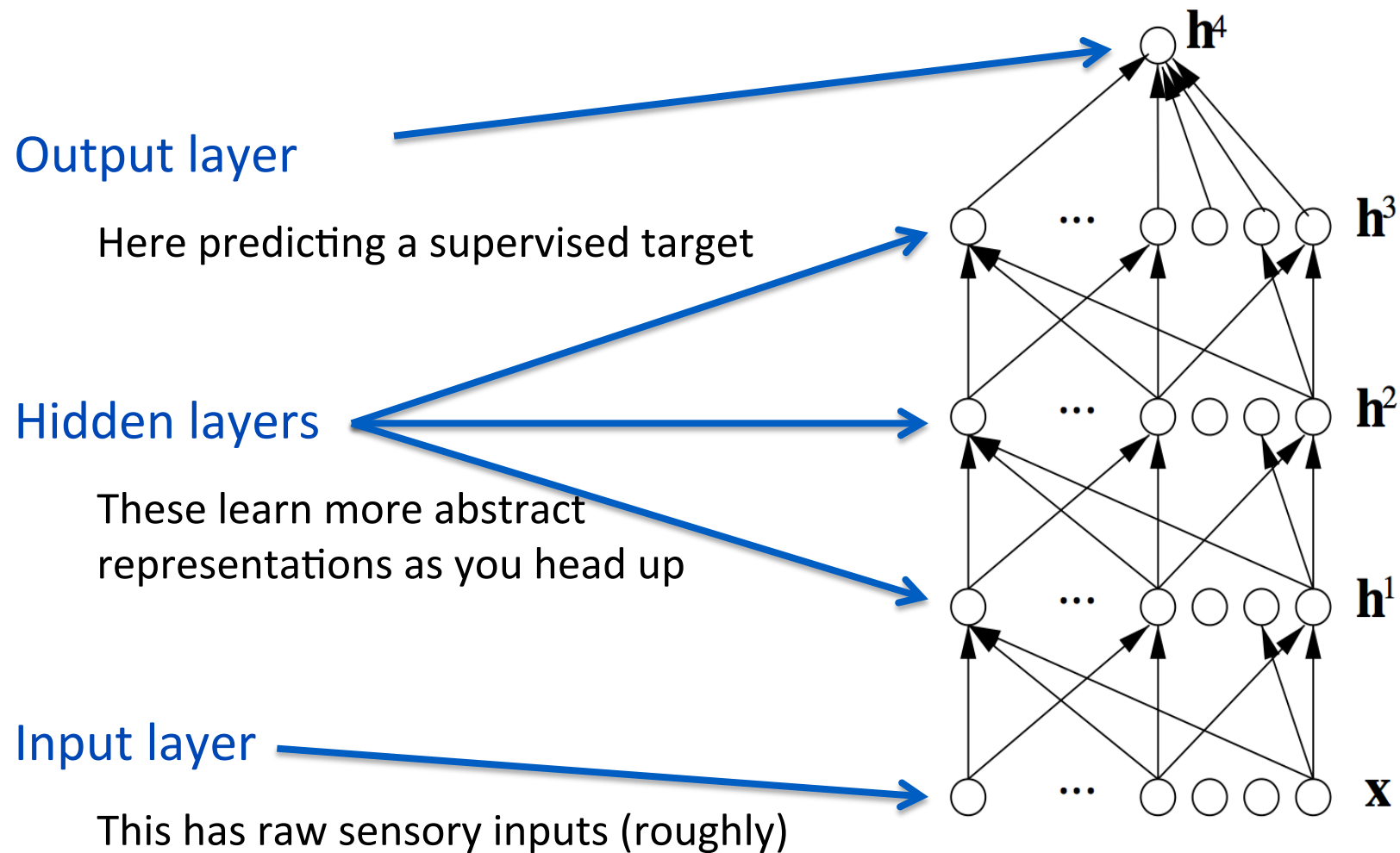

A (Vanilla) Modern Deep Architecture

Optional Output layer

Here predicting or conditioning on a supervised target

Hidden layers

These learn more abstract representations as you head up

Input layer

Inputs can be reconstructed, filled-in or sampled

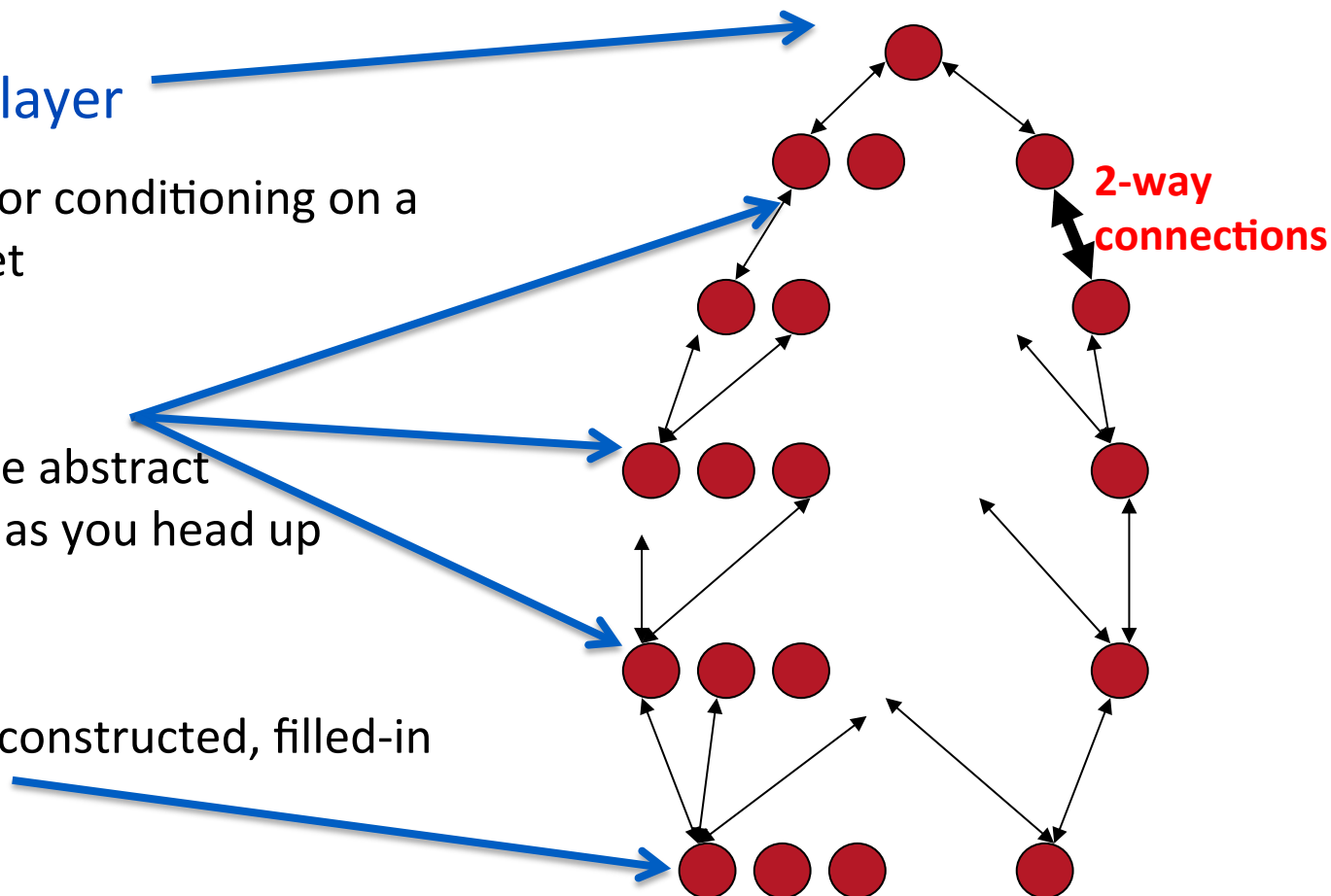

ML 101. What We Are Fighting Against: The Curse of Dimensionality

To generalize locally,
need representative
examples for all
relevant variations!

Classical solution: hope
for a smooth enough
target function, or
make it smooth by
handcrafting good
features / kernel

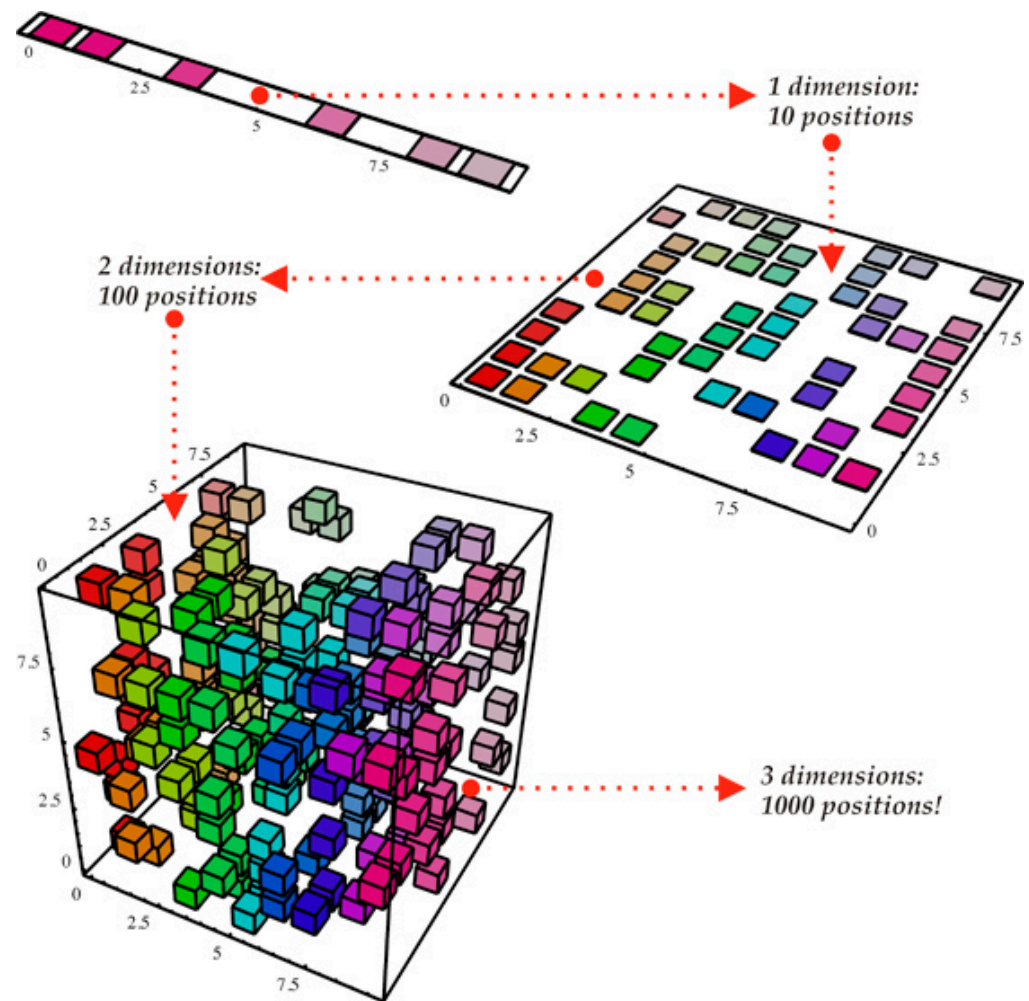

Easy Learning

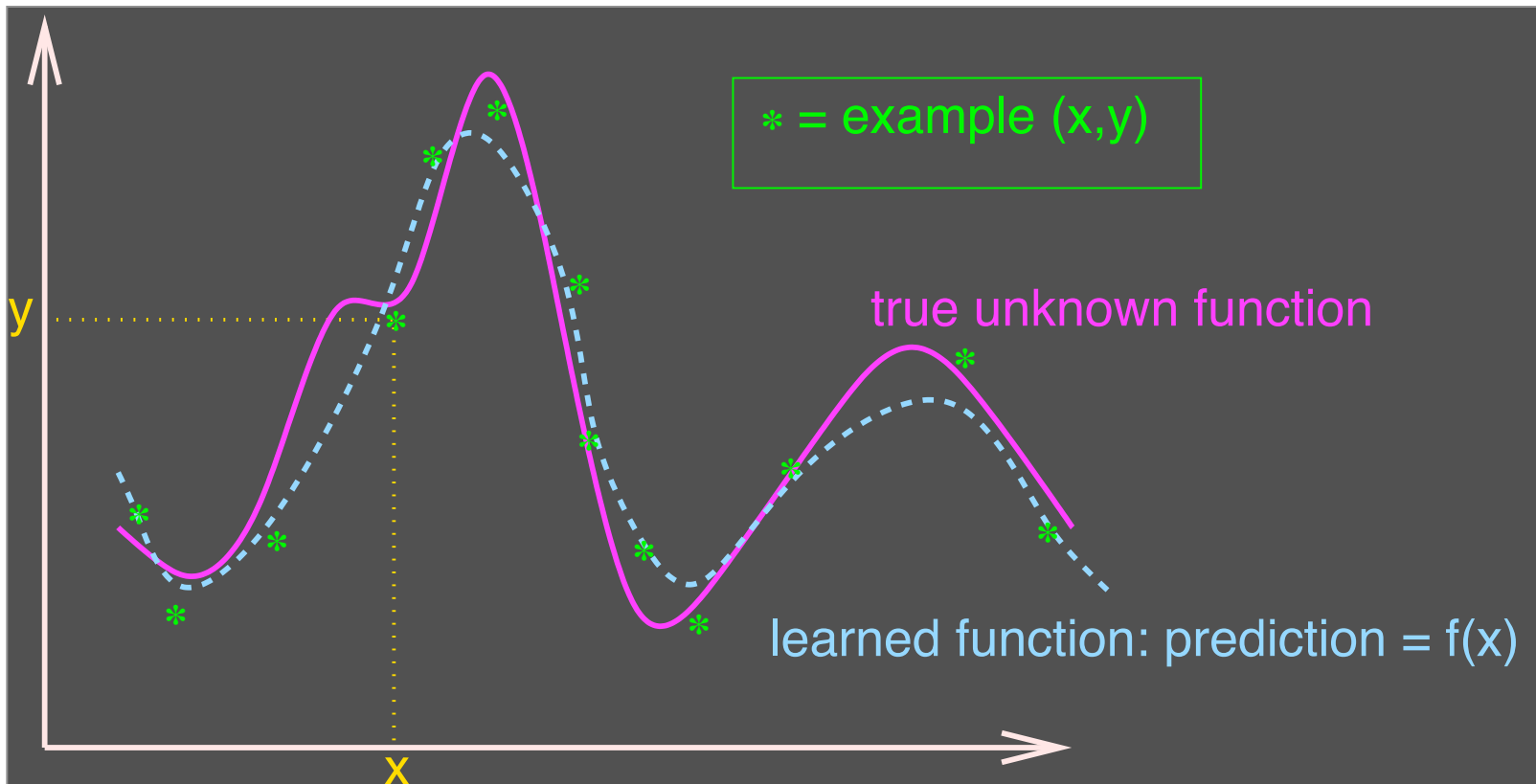

Local Smoothness Prior: Locally Capture the Variations

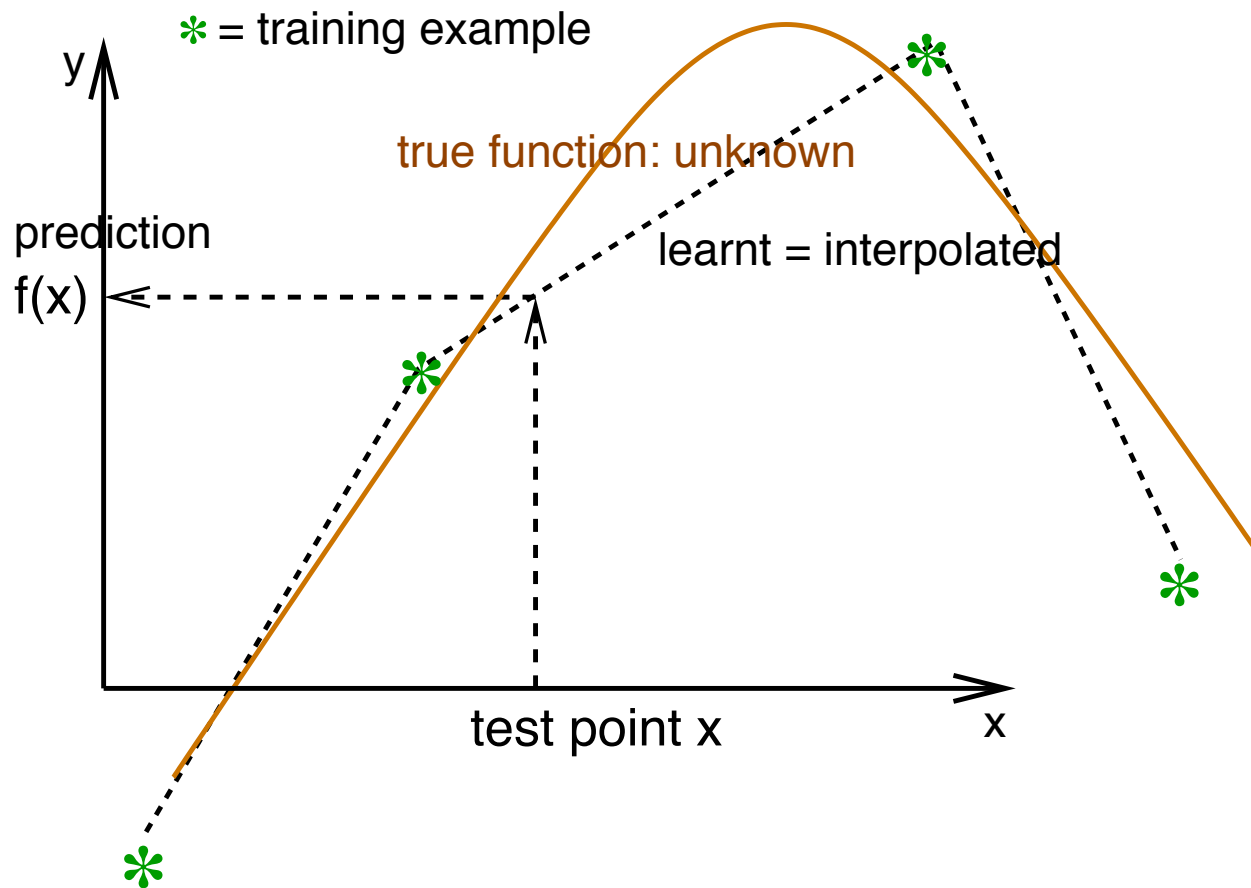

However, Real Data Are near Highly Curved Sub-Manifolds

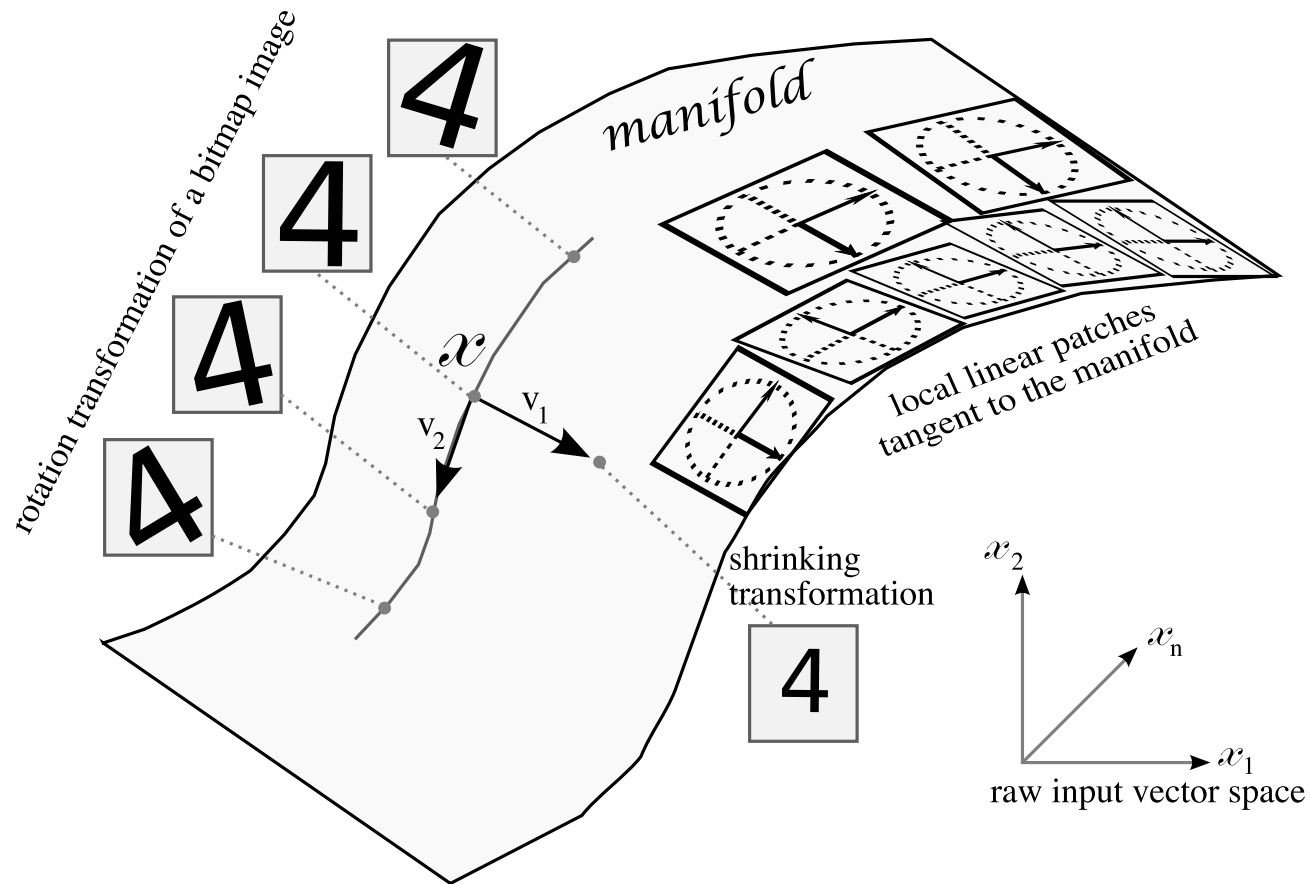

Not Dimensionality so much as Number of Variations



(Bengio, Dellalleau & Le Roux 2007)

- **Theorem:** Gaussian kernel machines need at least k examples to learn a function that has $2k$ zero-crossings along some line

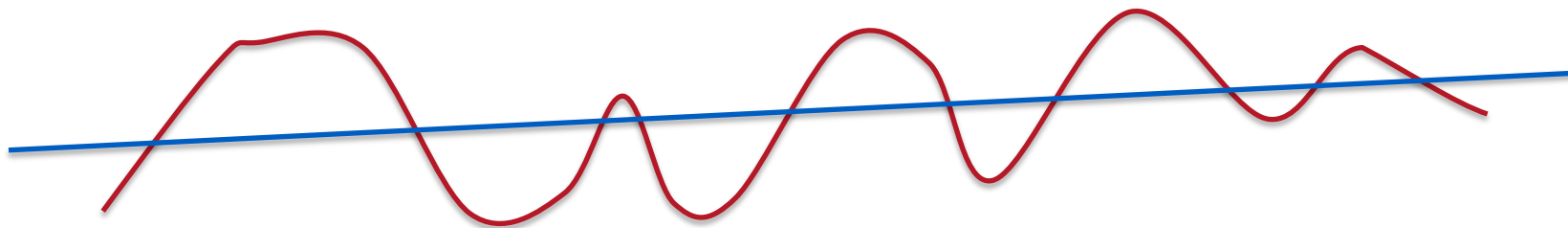

- **Theorem:** For a Gaussian kernel machine to learn some maximally varying functions over d inputs requires $O(2^d)$ examples

Putting Probability Mass where Structure is Plausible

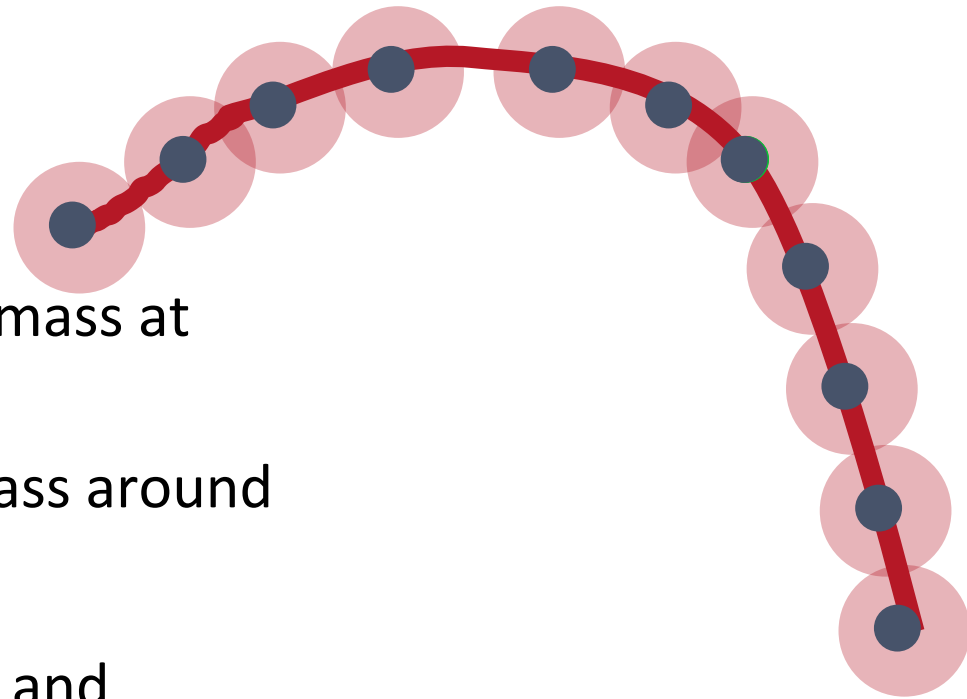

- Empirical distribution: mass at training examples
- Smoothness: spread mass around
- Insufficient
- Guess some 'structure' and generalize accordingly

Is there any hope to
generalize non-locally?

Yes! Need good priors!

Part 1

Six Good Reasons to Explore Representation Learning

#1 Learning features, not just handcrafting them

Most ML systems use very carefully hand-designed features and representations

Many practitioners are very experienced – and good – at such feature design (or kernel design)

“Machine learning” often reduces to linear models (including CRFs) and nearest-neighbor-like features/models (including n-grams, kernel SVMs, etc.)

Hand-crafting features is time-consuming, brittle, incomplete

#2 The need for distributed representations

Clustering

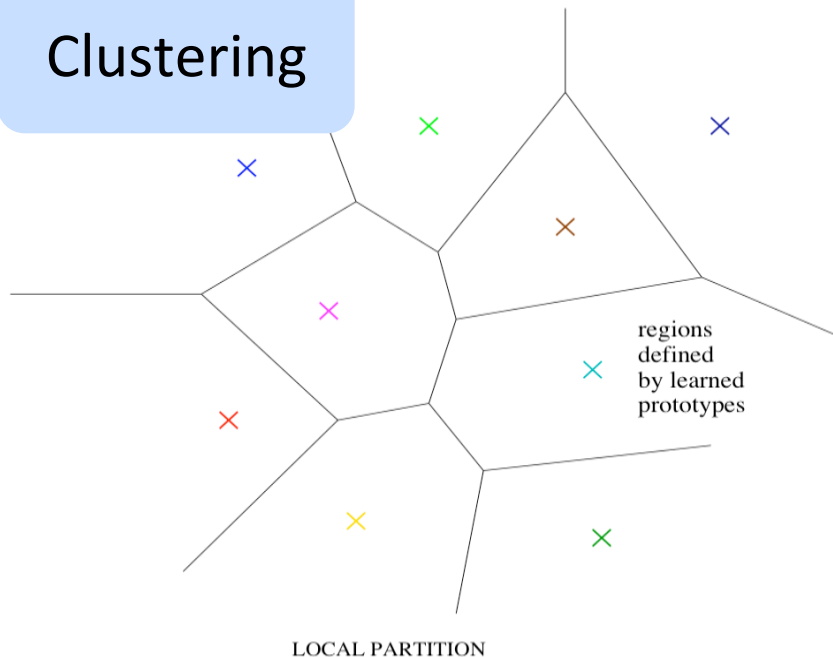

- Clustering, Nearest-Neighbors, RBF SVMs, local non-parametric density estimation & prediction, decision trees, etc.
- Parameters for each distinguishable region
- **# of distinguishable regions is linear in # of parameters**

→ No non-trivial generalization to regions without examples

#2 The need for distributed representations

- Factor models, PCA, RBMs, Neural Nets, Sparse Coding, Deep Learning, etc.
- Each parameter influences many regions, not just local neighbors
- **# of distinguishable regions grows almost exponentially with # of parameters**
- **GENERALIZE NON-LOCALLY TO NEVER-SEEN REGIONS**

Multi-Clustering

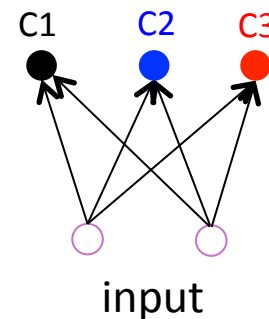
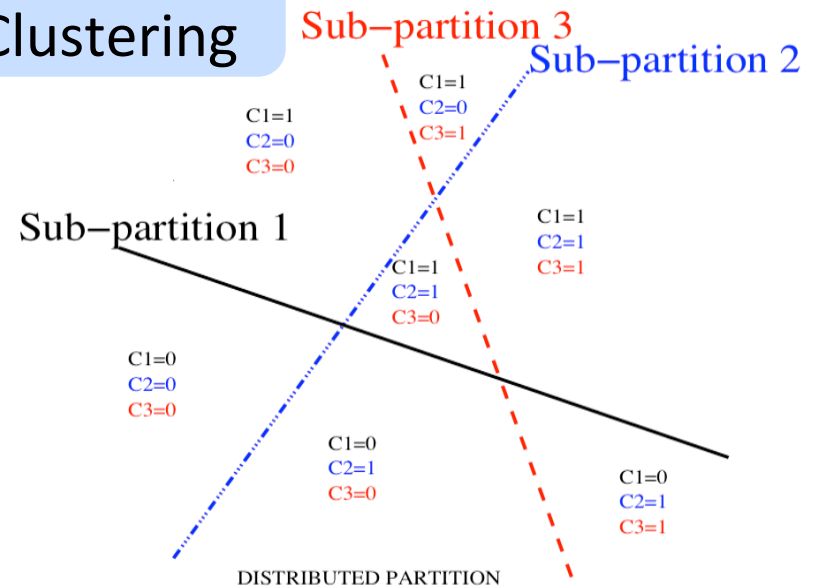

Non-mutually exclusive features/ attributes create a combinatorially large set of distinguishable configurations

#2 The need for distributed representations

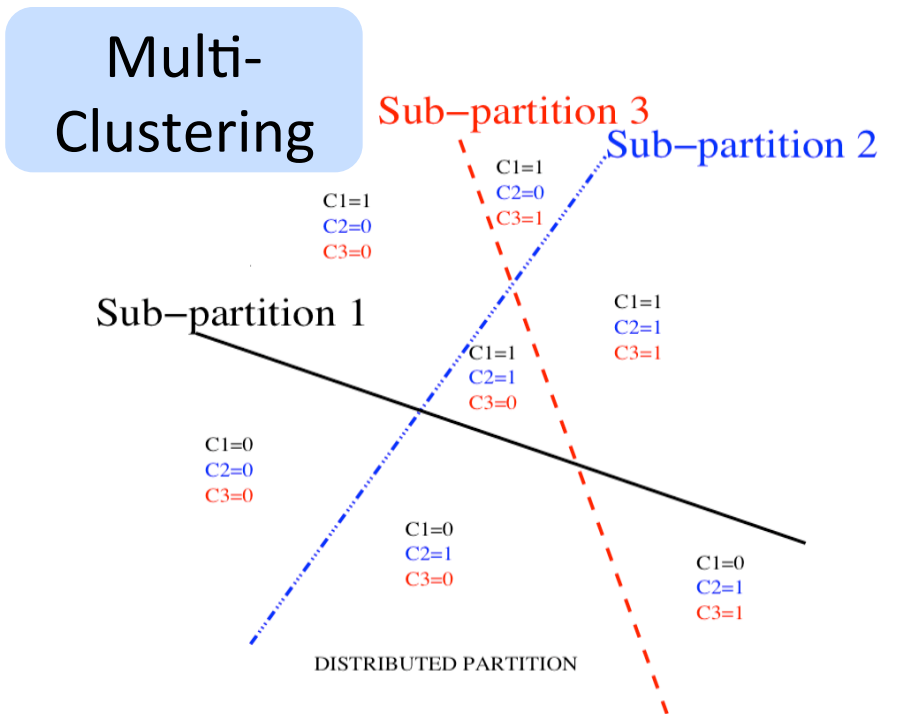
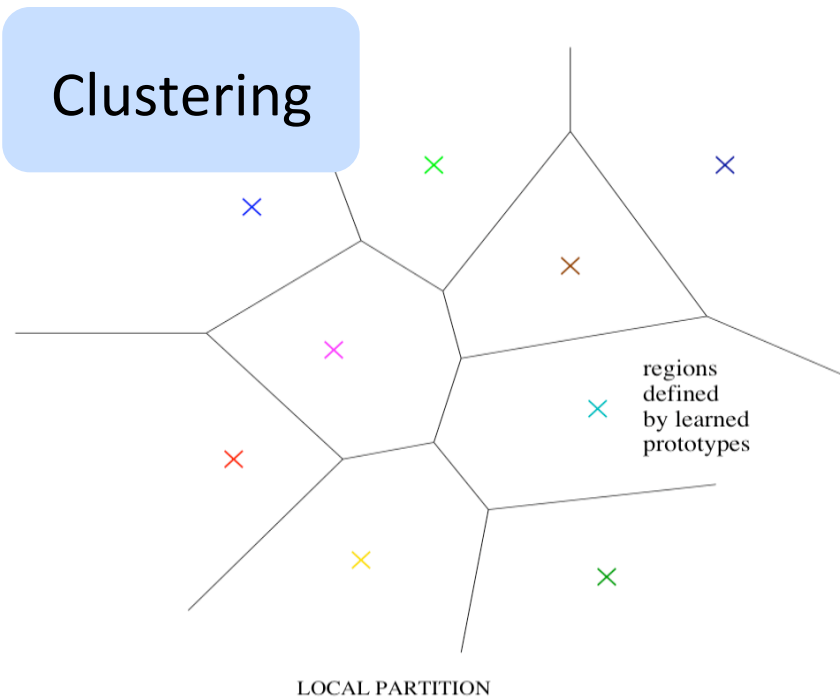

Learning a **set of features** that are not mutually exclusive can be **exponentially more statistically efficient** than having nearest-neighbor-like or clustering-like models

#3 Unsupervised feature learning

Today, most practical ML applications require (lots of) labeled training data

But almost all **data is unlabeled**

The brain needs to learn about 10^{14} synaptic strengths

... in about 10^9 seconds

Labels cannot possibly provide enough information

Most information acquired in an **unsupervised** fashion

#3 How do humans generalize from very few examples?

- They **transfer** knowledge from previous learning:
 - Representations
 - Explanatory factors
- Previous learning from: unlabeled data
 - + labels for other tasks
- **Prior: shared underlying explanatory factors, in particular between $P(x)$ and $P(Y|x)$**

#3 Sharing Statistical Strength by Semi-Supervised Learning

- Hypothesis: $P(x)$ shares structure with $P(y|x)$

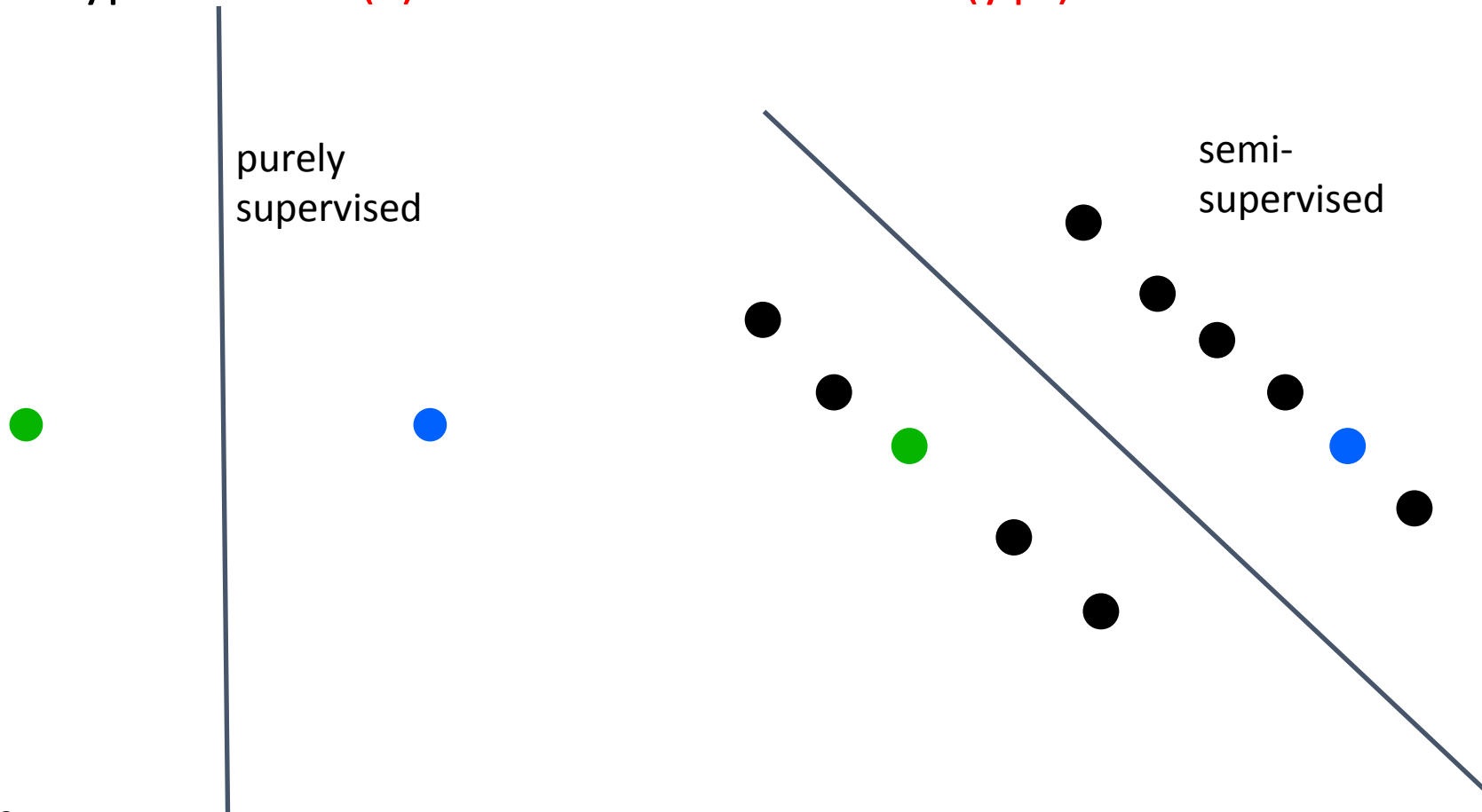

#4 Learning multiple levels of representation

There is theoretical and empirical evidence in favor of multiple levels of representation

Exponential gain for some families of functions

Biologically inspired learning

Brain has a deep architecture

Cortex seems to have a generic learning algorithm

Humans first learn simpler concepts and then compose them into more complex ones

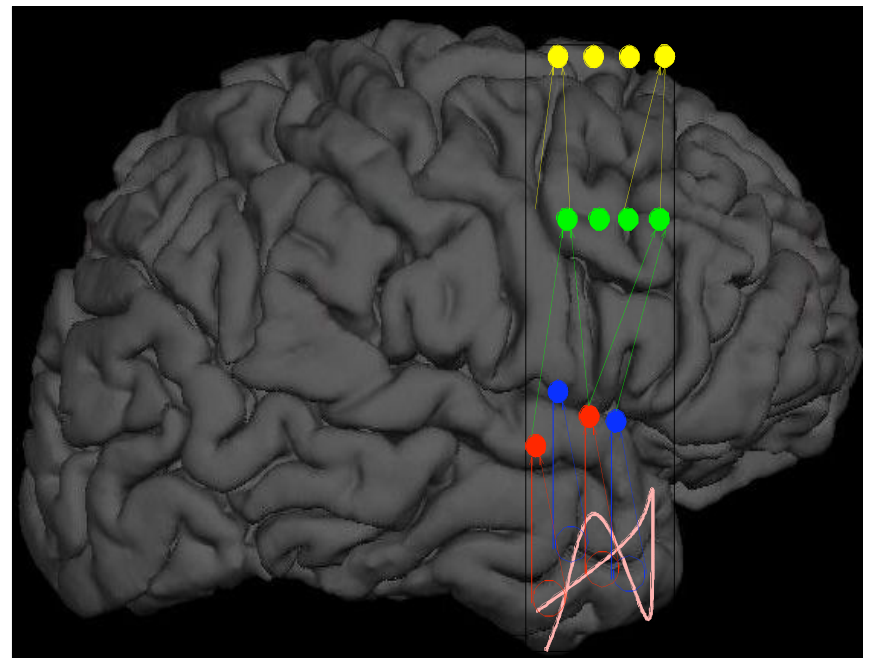

#4 Sharing Components in a Deep Architecture

Polynomial expressed with shared components: advantage of depth may grow exponentially

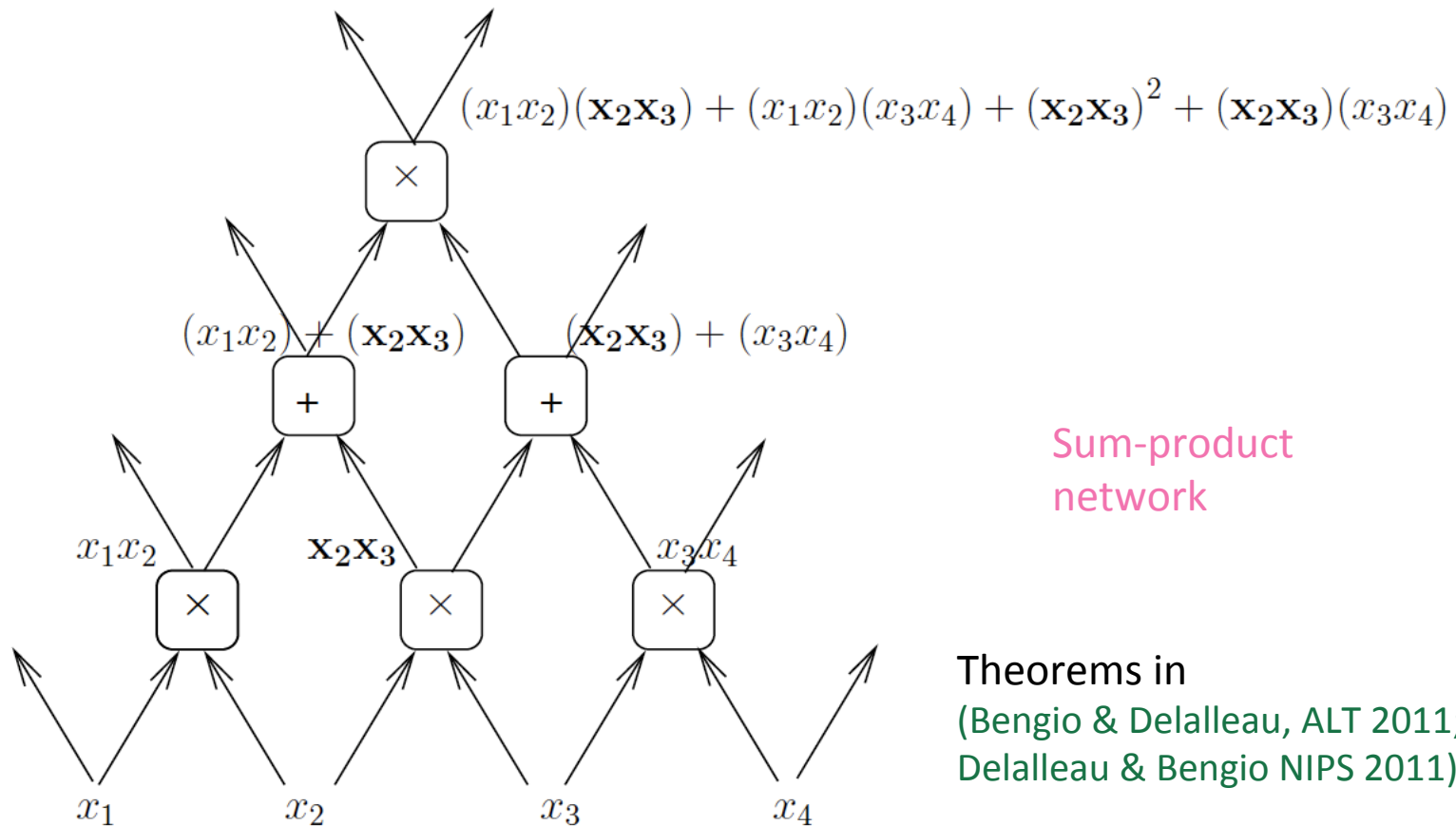

#4 Learning multiple levels of representation

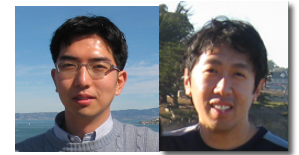

(Lee, Pham, Largman & Ng, NIPS 2009)
(Lee, Grosse, Ranganath & Ng, ICML 2009)

Successive model layers learn deeper intermediate representations

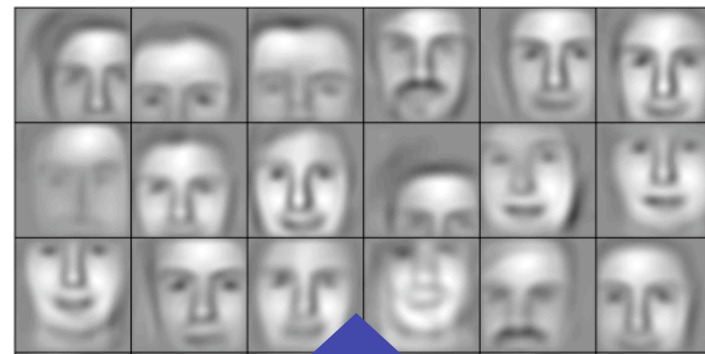

Layer 3

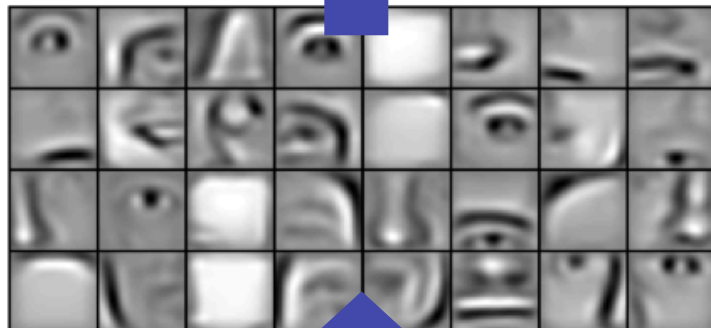

Layer 2



Layer 1

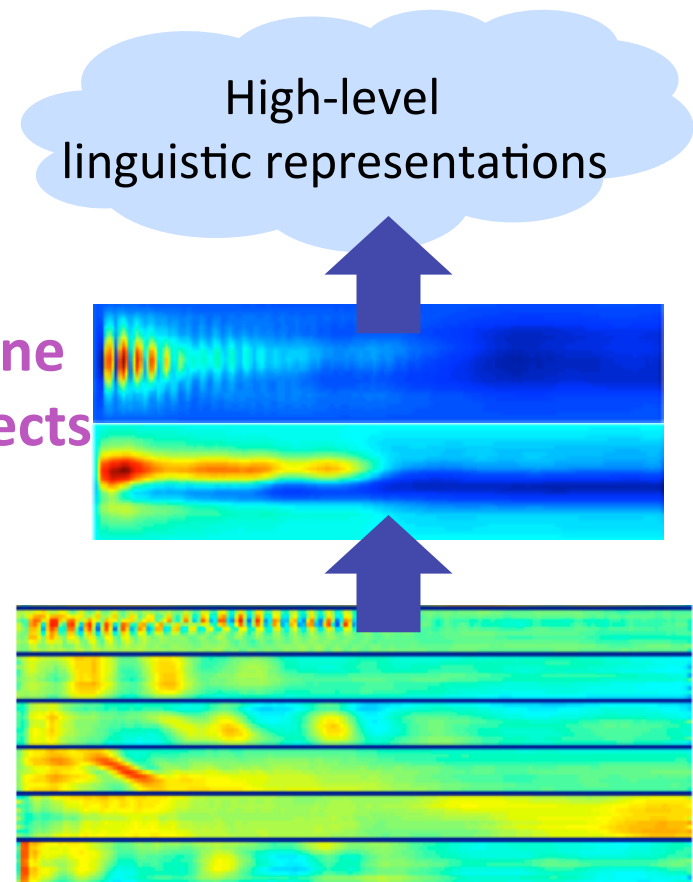

Parts combine to form objects

Prior: underlying factors & concepts compactly expressed w/ multiple levels of abstraction

#4 Handling the compositionality of human language and thought

- Human languages, ideas, and artifacts are composed from simpler components
- **Recursion**: the same operator (same parameters) is applied repeatedly on different states/components of the computation
- Result after unfolding = deep computation / representation

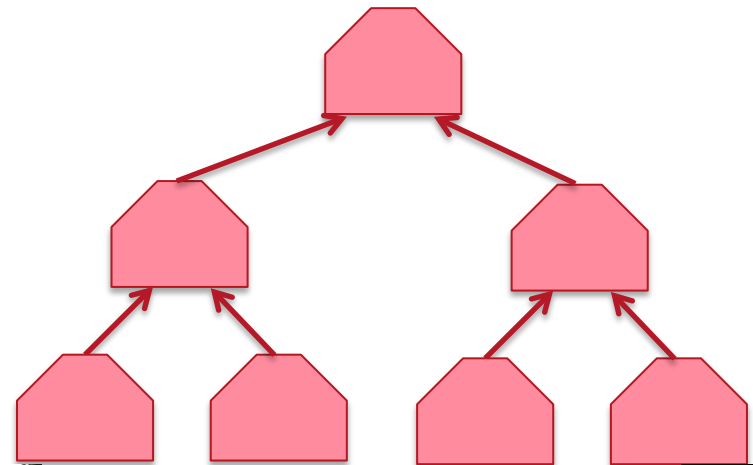
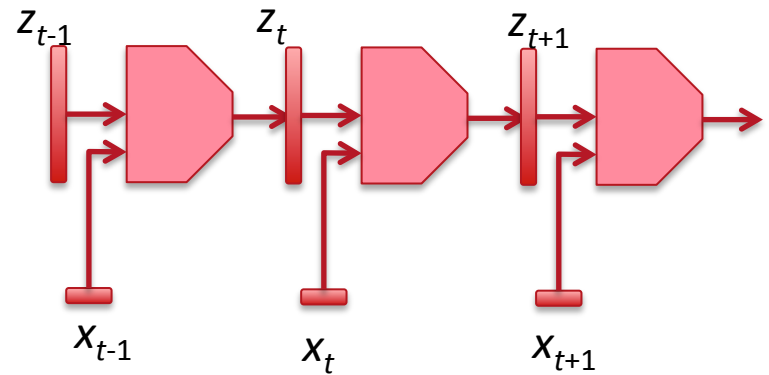

(Bottou 2011, Socher et al 2011)



#5 Multi-Task Learning

- Generalizing better to new tasks (tens of thousands!) is crucial to approach AI
- Deep architectures learn good intermediate representations that can be shared across tasks
(Collobert & Weston ICML 2008, Bengio et al AISTATS 2011)
- Good representations that disentangle underlying factors of variation make sense for many tasks because **each task concerns a subset of the factors**

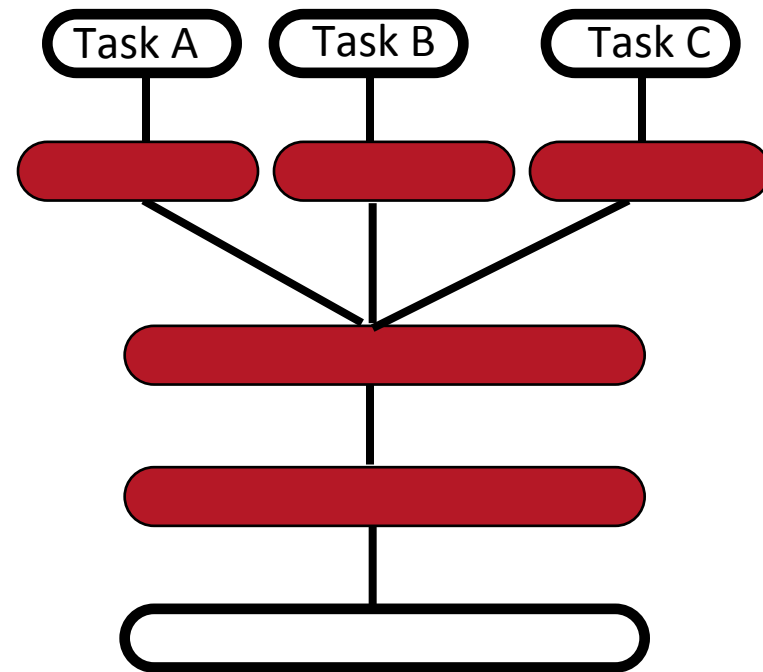

E.g. dictionary, with intermediate concepts re-used across many definitions

Prior: shared underlying explanatory factors between tasks

#5 Combining Multiple Sources of Evidence with Shared Representations

- Traditional ML: data = matrix
- Relational learning: multiple sources, different tuples of variables
- Share representations of same types across data sources
- Shared learned representations help propagate information among data sources: e.g., WordNet, XWN, Wikipedia, **FreeBase**, ImageNet...
(Bordes et al AISTATS 2012, ML J. 2013)

- **FACTS = DATA**

- **Deduction = Generalization**

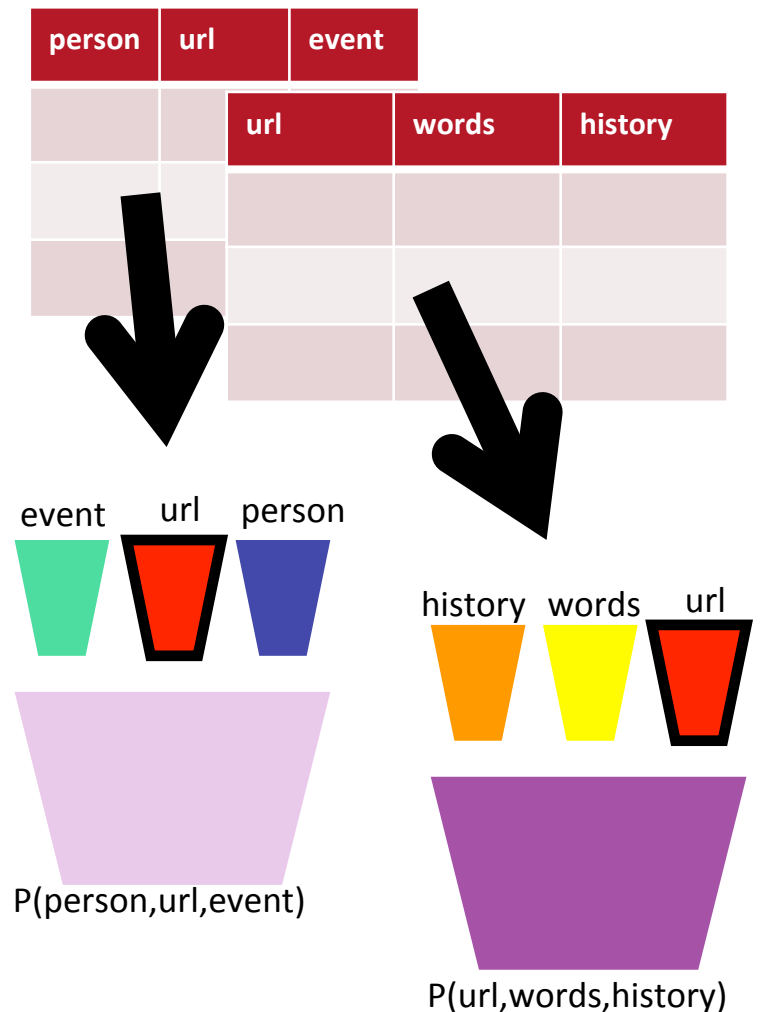

#5 Different object types represented in same space



Google:

S. Bengio, J. Weston & N. Usunier



(IJCAI 2011, NIPS'2010, JMLR 2010, ML J. 2010)



$\Phi_w(\text{DOLPHIN})$
DOLPHIN
OBAMA
EIFFEL TOWER
.....

$\Phi_I(\text{EIFFEL TOWER})$

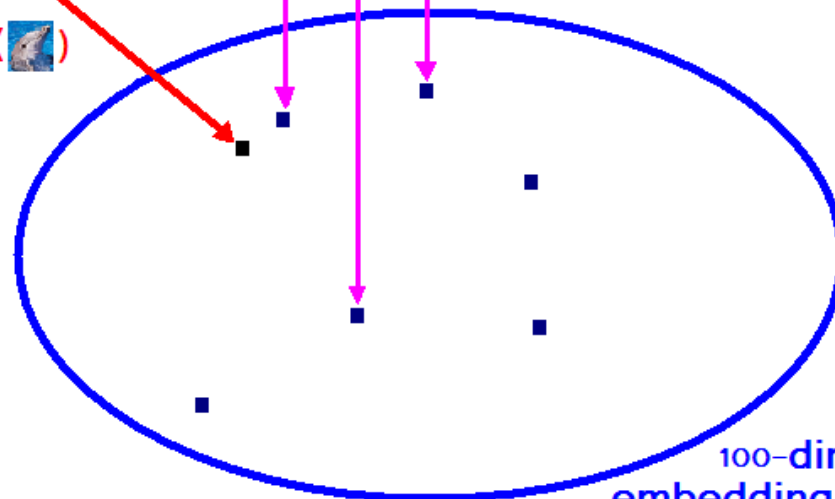

Learn $\Phi_I(\cdot)$ and $\Phi_w(\cdot)$ to optimize precision@k.

#6 Invariance and Disentangling

- Invariant features
- Which invariances?
- Alternative: learning to disentangle factors
- Good disentangling →
avoid the curse of dimensionality



#6 Emergence of Disentangling

- (Goodfellow et al. 2009): sparse auto-encoders trained on images
 - some higher-level features more invariant to geometric factors of variation
- (Glorot et al. 2011): sparse rectified denoising auto-encoders trained on bags of words for sentiment analysis
 - different features specialize on different aspects (domain, sentiment)

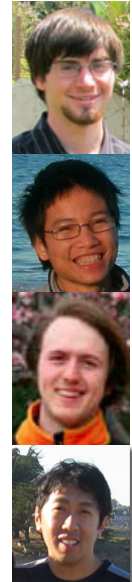

WHY?

#6 Sparse Representations

- Just add a sparsifying penalty on learned representation (prefer 0s in the representation)
- Information disentangling (compare to dense compression)
- More likely to be linearly separable (high-dimensional space)
- Locally low-dimensional representation = local chart
- Hi-dim. sparse = efficient variable size representation
= data structure

Few bits of information



Many bits of information



Prior: only few concepts and attributes relevant per example

Deep Sparse Rectifier Neural Networks

(Glorot, Bordes and Bengio AISTATS 2011), following up on (Nair & Hinton 2010) softplus RBMs

Neuroscience motivations

Leaky integrate-and-fire model

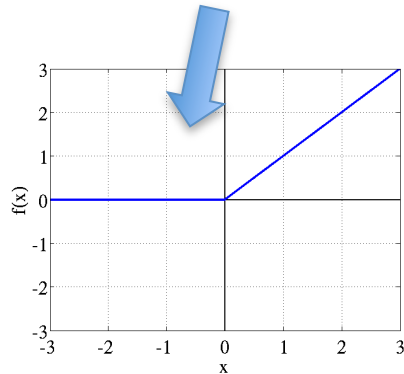

Rectifier
 $f(x) = \max(0, x)$

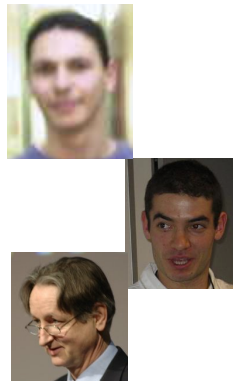
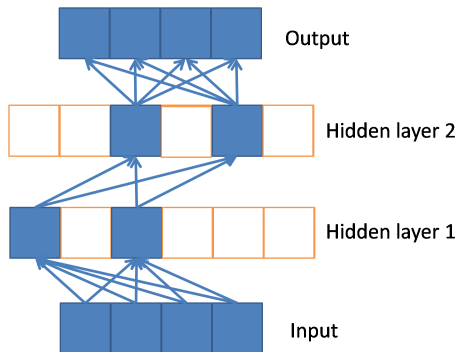

Machine learning motivations

- ➔ Sparse representations
- ➔ Sparse gradients
- ➔ *Trains deep nets even w/o pretraining*



mite	container ship	motor scooter	leopard
mite	container ship	motor scooter	leopard
black widow	lifeboat	go-kart	jaguar
cockroach	amphibian	moped	cheetah
tick	fireboat	bumper car	snow leopard
starfish	drilling platform	golfcart	Egyptian cat

Outstanding results by Krizhevsky et al 2012
killing the state-of-the-art on ImageNet 1000:

	1 st choice	Top-5
2 nd best		27% err
Previous SOTA	45% err	26% err
Krizhevsky et al	37% err	15% err

Temporal Coherence and Scales

- Hints from nature about different explanatory factors:
 - Rapidly changing factors (often noise)
 - Slowly changing (generally more abstract)
 - Different factors at different time scales
- Exploit those **hints** to **disentangle** better!
- (Becker & Hinton 1993, Wiskott & Sejnowski 2002, Hurri & Hyvarinen 2003, Berkes & Wiskott 2005, Mobahi et al 2009, Bergstra & Bengio 2009)

Bypassing the curse

We need to build **compositionality** into our ML models

Just as human languages exploit compositionality to give representations and meanings to complex ideas

Exploiting compositionality gives an exponential gain in representational power

Distributed representations / embeddings: **feature learning**

Deep architecture: **multiple levels of feature learning**

Prior: compositionality is useful to describe the world around us efficiently

Bypassing the curse by sharing statistical strength

- Besides very fast GPU-enabled predictors, the main advantage of representation learning is **statistical**: potential to learn from less labeled examples because of sharing of statistical strength:
 - Unsupervised pre-training and semi-supervised training
 - Multi-task learning
 - Multi-data sharing, learning about symbolic objects and their relations

Unsupervised and Transfer Learning Challenge + Transfer Learning Challenge: Deep Learning 1st Place

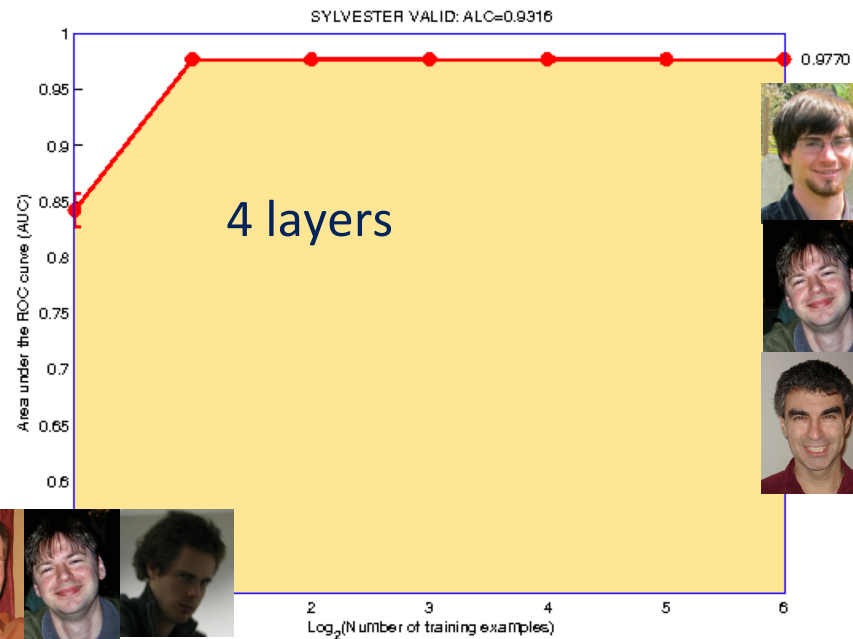
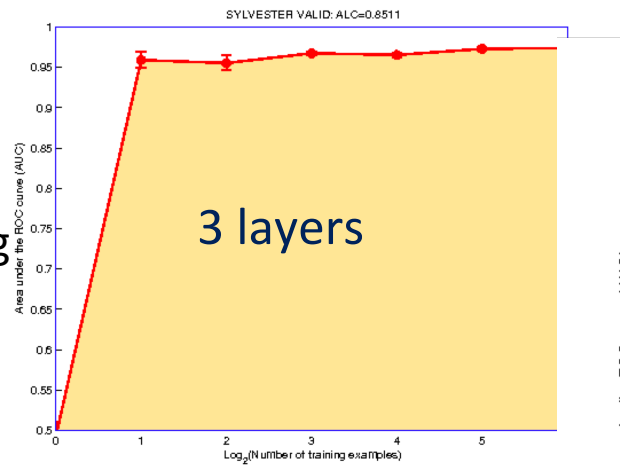
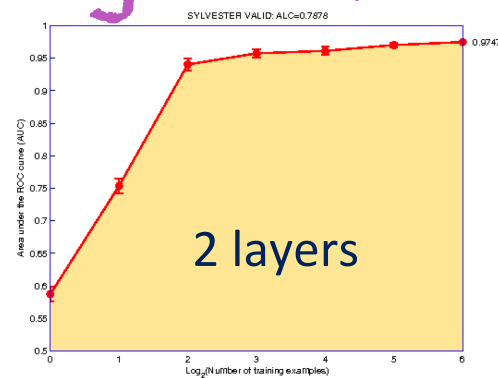
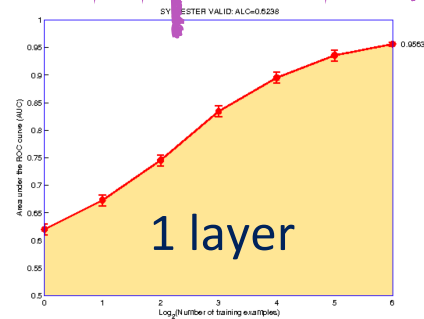
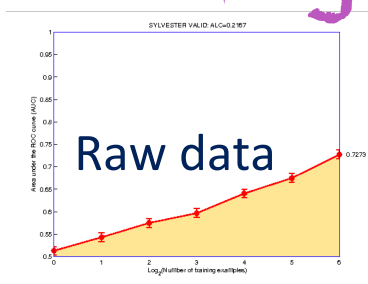

NIPS'2011
Transfer Learning
Challenge
Paper:
ICML'2012

ICML'2011
workshop on
Unsup. &
Transfer Learning

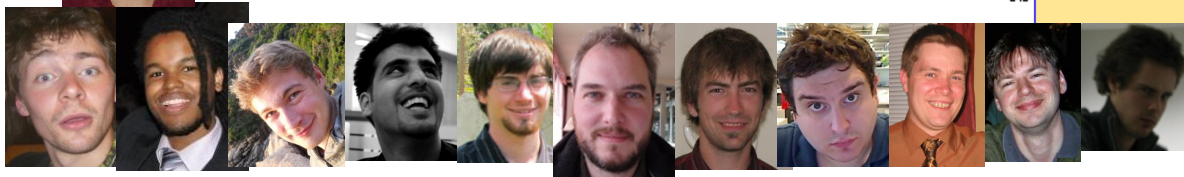

Why now?

Despite prior investigation and understanding of many of the algorithmic techniques ...

Before 2006 training deep architectures was **unsuccessful**

(except for convolutional neural nets when used by people who speak French)

What has changed?

- New methods for unsupervised pre-training have been developed (variants of Restricted Boltzmann Machines = RBMs, regularized auto-encoders, sparse coding, etc.)
- New methods to successfully train deep supervised nets even without unsupervised pre-training
- Successful real-world applications, winning challenges and beating SOTAs in various areas, large-scale industrial apps

Major Breakthrough in 2006



- Ability to train deep architectures by using layer-wise unsupervised learning, whereas previous purely supervised attempts had failed
- Unsupervised feature learners:
 - RBMs
 - Auto-encoder variants
 - Sparse coding variants



2012: Industrial-scale success in speech recognition

- Google uses DL in their android speech recognizer (both server-side and on some phones with enough memory)
- Microsoft uses DL in their speech recognizer
- Error reductions on the order of 30%, a major progress

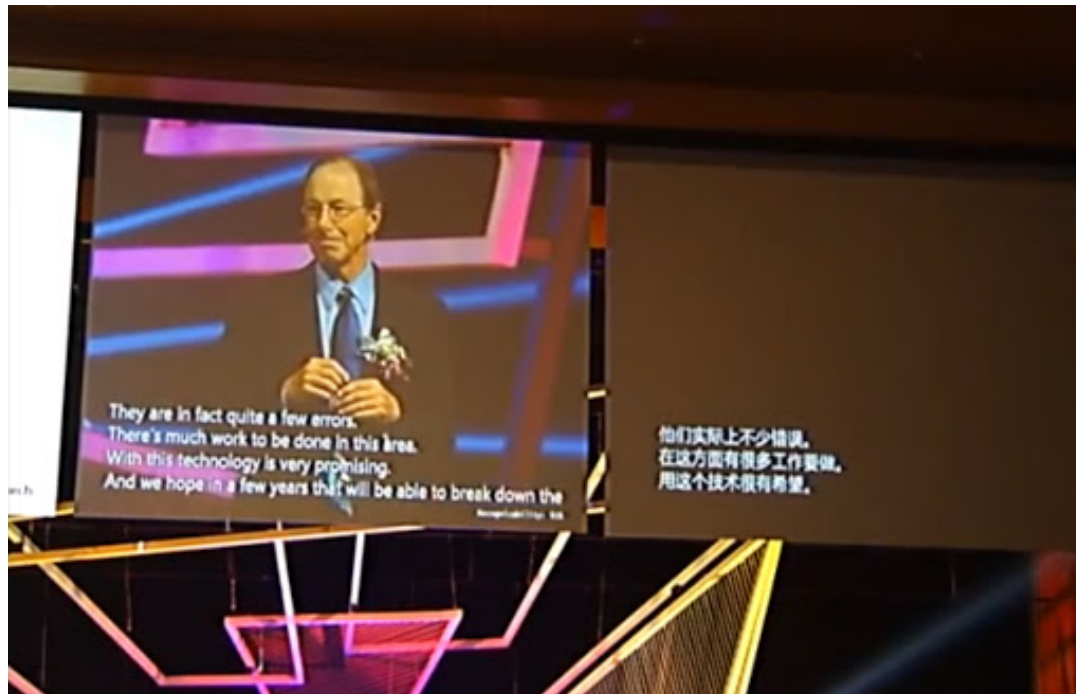

Deep Networks for Speech Recognition: results from Google, IBM, Microsoft

task	Hours of training data	Deep net+HMM	GMM+HMM same data	GMM+HMM more data
Switchboard	309	16.1	23.6	17.1 (2k hours)
English Broadcast news	50	17.5	18.8	
Bing voice search	24	30.4	36.2	
Google voice input	5870	12.3		16.0 (lots more)
Youtube	1400	47.6	52.3	

Industrial-scale success in object recognition

- Krizhevsky, Sutskever & Hinton NIPS 2012

	1 st choice	Top-5
2 nd best		27% err
Previous SOTA	45% err	26% err
Krizhevsky et al	37% err	15% err

- Google incorporates DL in Google+ photo search, “A step across the semantic gap” (Google Research blog, June 12, 2013)
- Baidu now offers with similar services

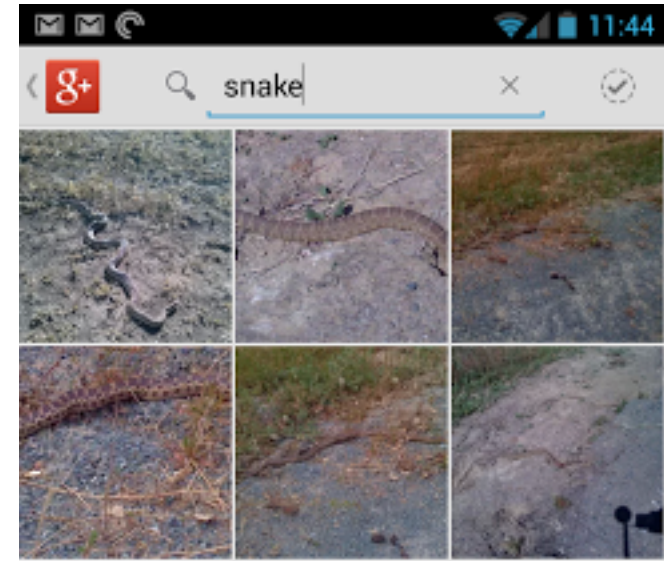

baby

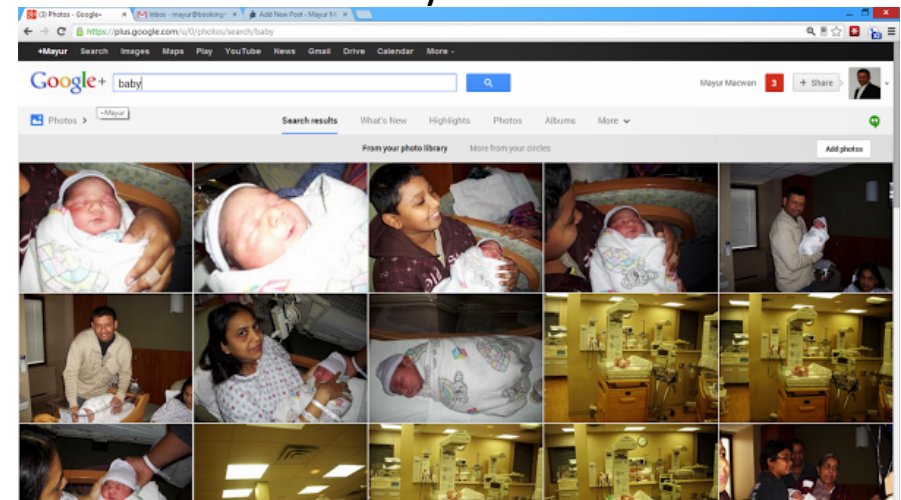

car

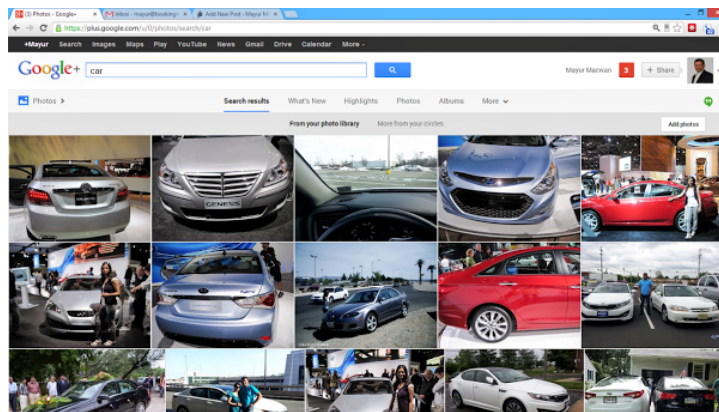

More Successful Applications

- Microsoft uses DL for speech rec. service (audio video indexing), based on Hinton/Toronto's DBNs (Mohamed et al 2012)
- Google uses DL in its Google Goggles service, using Ng/Stanford DL systems, and in its Google+ photo search service, using deep convolutional nets
- NYT talks about these: http://www.nytimes.com/2012/06/26/technology/in-a-big-network-of-computers-evidence-of-machine-learning.html?_r=1
- Substantially beating SOTA in language modeling (perplexity from 140 to 102 on Broadcast News) for speech recognition (WSJ WER from 16.9% to 14.4%) (Mikolov et al 2011) and translation (+1.8 BLEU) (Schwenk 2012)
- SENNA: Unsup. pre-training + multi-task DL reaches SOTA on POS, NER, SRL, chunking, parsing, with >10x better speed & memory (Collobert et al 2011)
- Recursive nets surpass SOTA in paraphrasing (Socher et al 2011)
- Denoising AEs substantially beat SOTA in sentiment analysis (Glorot et al 2011)
- Contractive AEs SOTA in knowledge-free MNIST (.8% err) (Rifai et al NIPS 2011)
- Le Cun/NYU's stacked PSDs most accurate & fastest in pedestrian detection and DL in top 2 winning entries of German road sign recognition competition

Already Many NLP Applications of DL

- Language Modeling (Speech Recognition, Machine Translation)
- Acoustic Modeling
- Part-Of-Speech Tagging
- Chunking
- Named Entity Recognition
- Semantic Role Labeling
- Parsing
- Sentiment Analysis
- Paraphrasing
- Question-Answering
- Word-Sense Disambiguation

Neural Language Model

- *Bengio et al NIPS'2000 and JMLR 2003 "A Neural Probabilistic Language Model"*



- Each word represented by a distributed continuous-valued code vector = embedding
- Generalizes to sequences of words that are **semantically similar** to training sequences

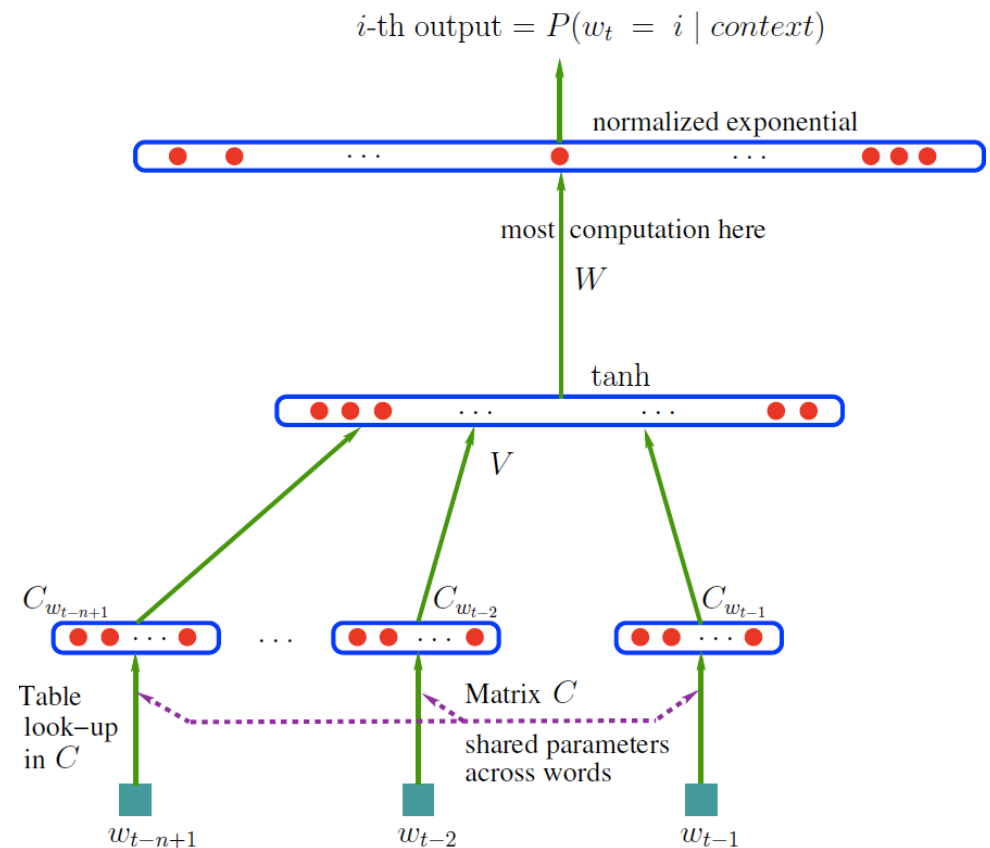

Neural word embeddings - visualization



Analogical Representations for Free (Mikolov et al, ICLR 2013)

- Semantic relations appear as linear relationships in the space of learned representations
- King – Queen \approx Man – Woman
- Paris – France + Italy \approx Rome

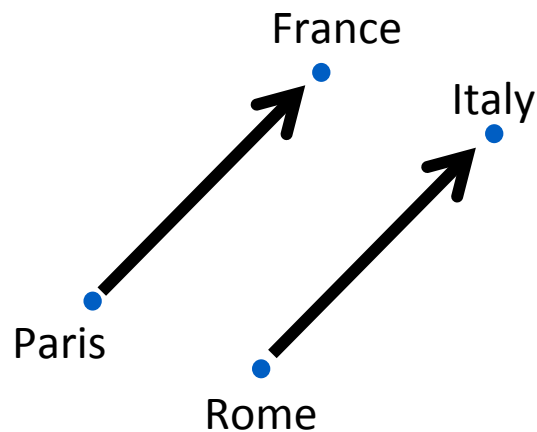



More about depth

Architecture Depth

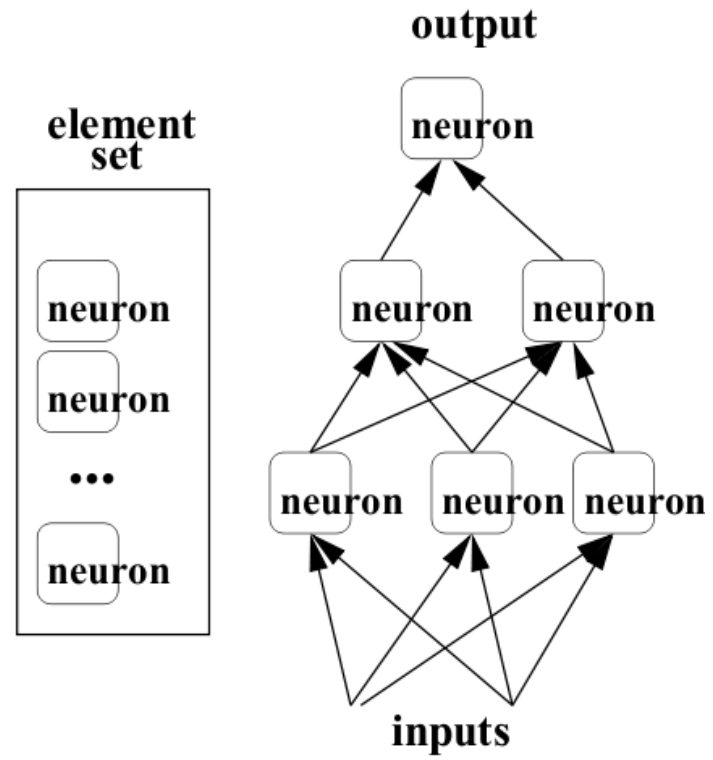
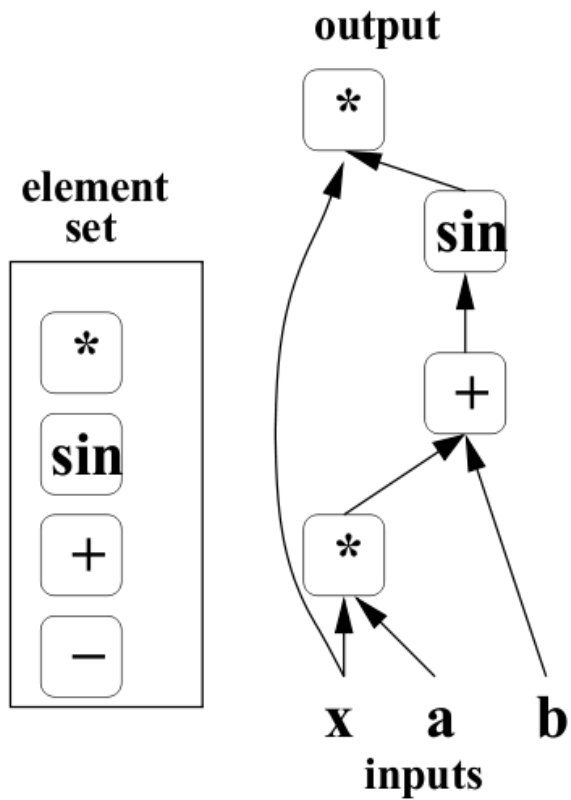

Deep Architectures are More Expressive

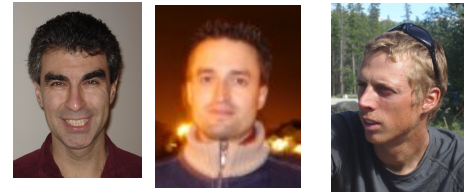

Theoretical arguments:

2 layers of $\left\{ \begin{array}{l} \text{Logic gates} \\ \text{Formal neurons} \\ \text{RBF units} \end{array} \right.$ = universal approximator

RBMs & auto-encoders = universal approximator

Theorems on advantage of depth:
(Hastad et al 86 & 91, Bengio et al 2007, Bengio & Delalleau 2011, Braverman 2011)

Some functions compactly represented with k layers may require exponential size with 2 layers

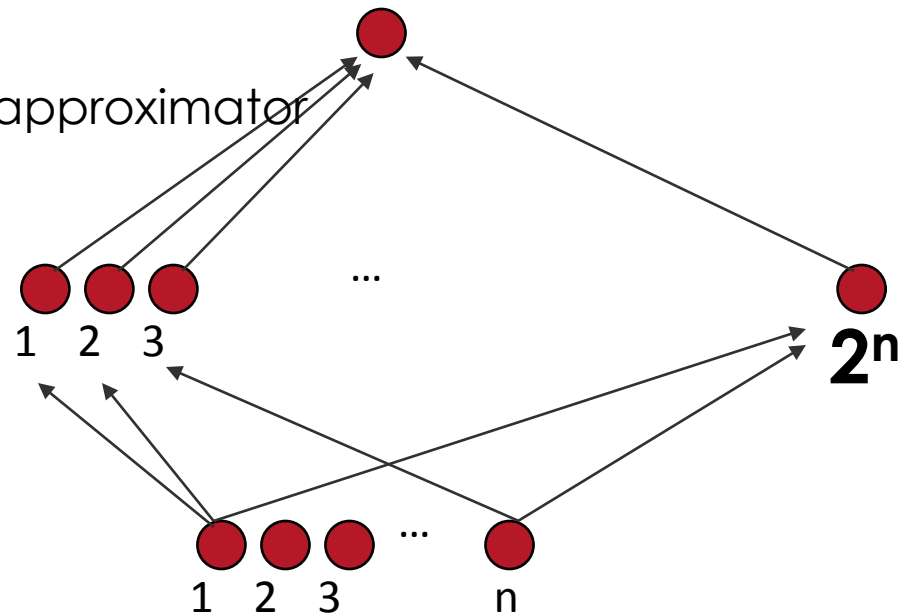

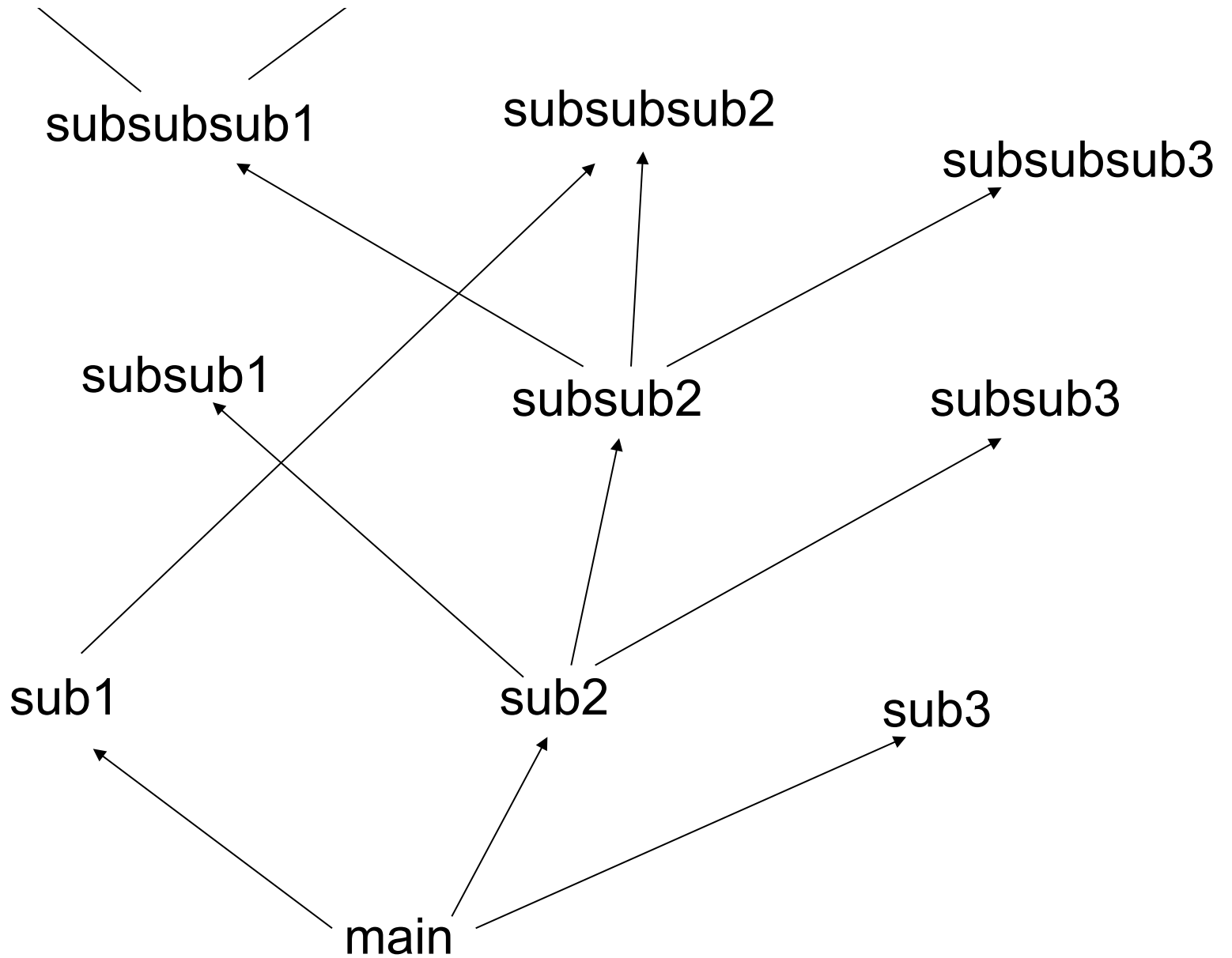

“Deep” computer program

subroutine1 includes
subsub1 code and
subsub2 code and
subsubsub1 code

subroutine2 includes
subsub2 code and
subsub3 code and
subsubsub3 code and ...

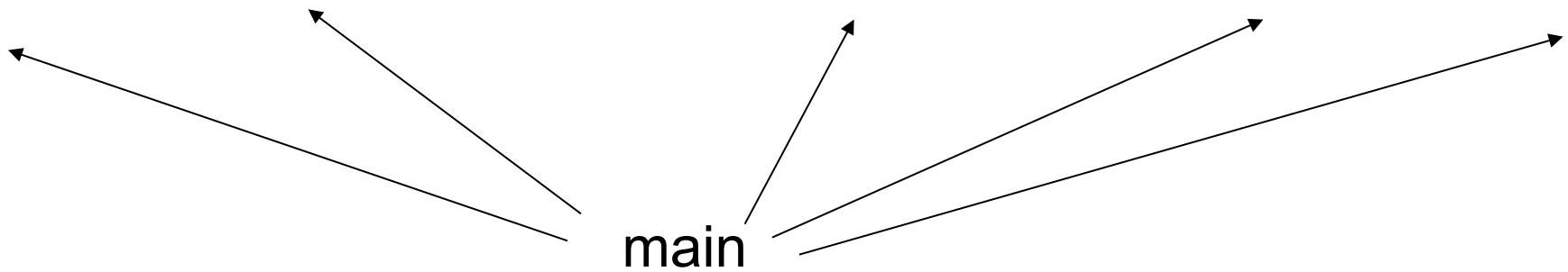

“Shallow” computer program

“Deep” circuit

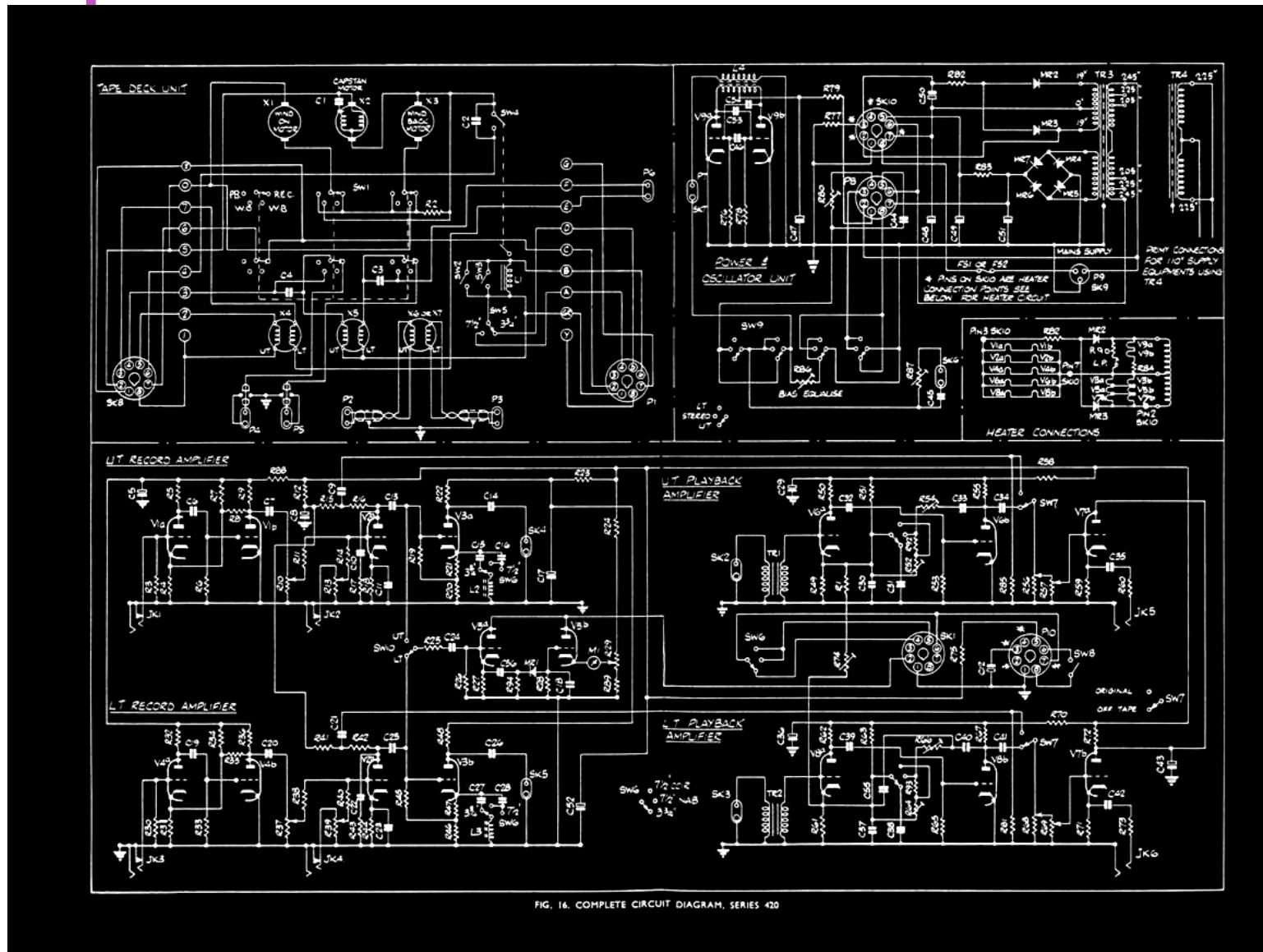
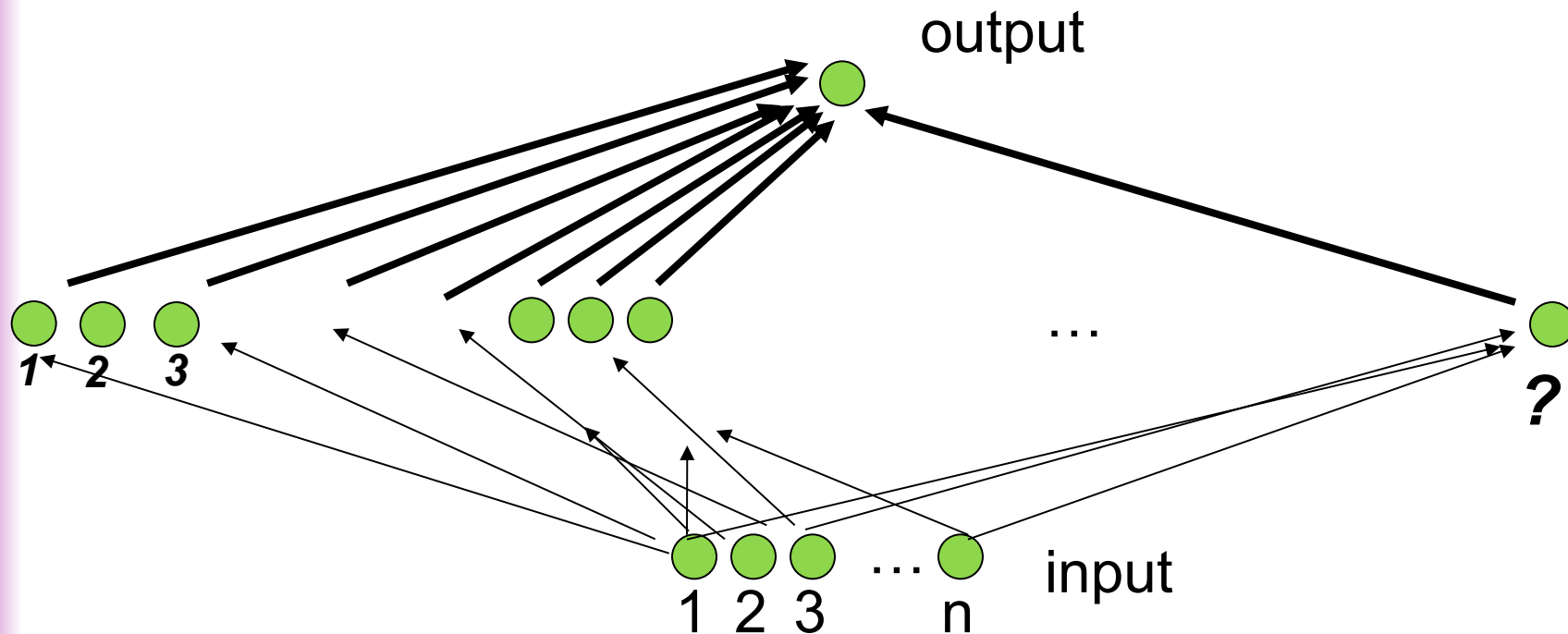
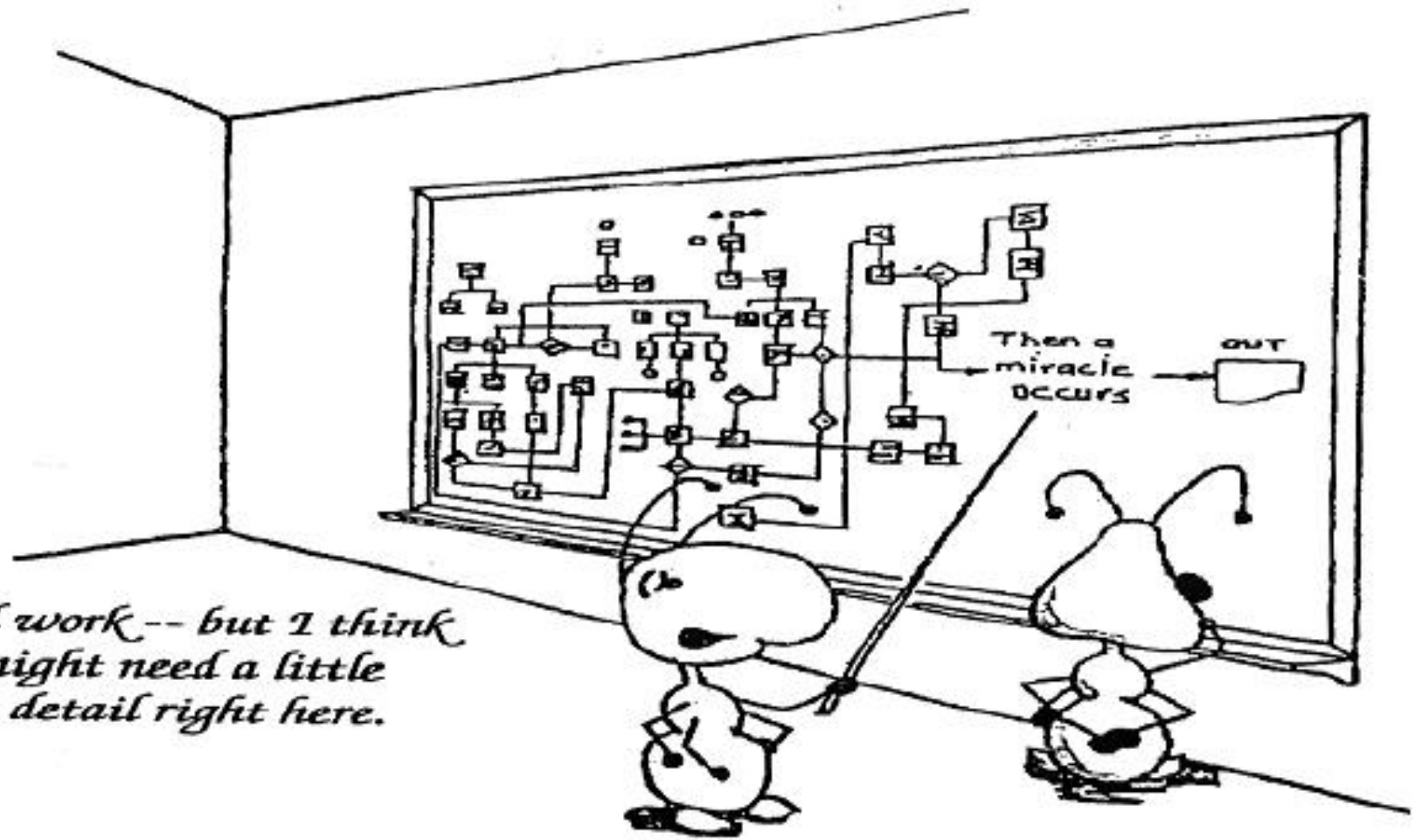

FIG. 16. COMPLETE CIRCUIT DIAGRAM, SERIES 420

"Shallow" circuit



Falsely reassuring theorems: one can approximate any reasonable (smooth, boolean, etc.) function with a 2-layer architecture



Good work -- but I think we might need a little more detail right here.

Part 2

Representation Learning Algorithms

A neural network = running several logistic regressions at the same time

If we feed a vector of inputs through a bunch of logistic regression functions, then we get a vector of outputs

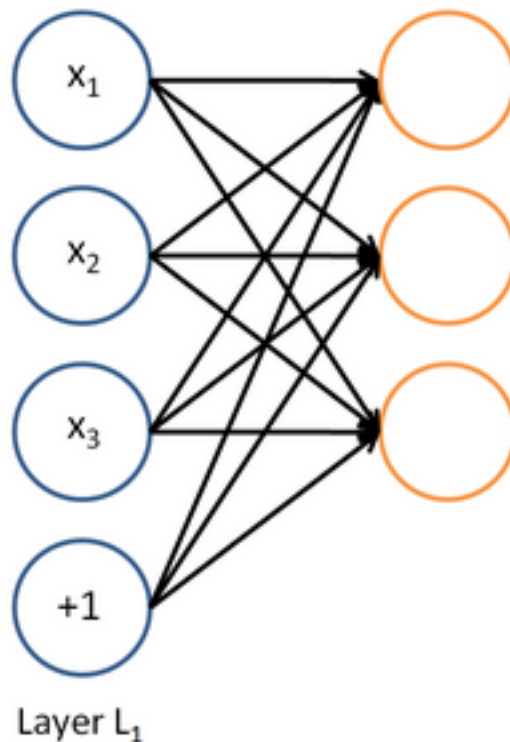

But we don't have to decide ahead of time what variables these logistic regressions are trying to predict!

A neural network = running several logistic regressions at the same time

... which we can feed into another logistic regression function

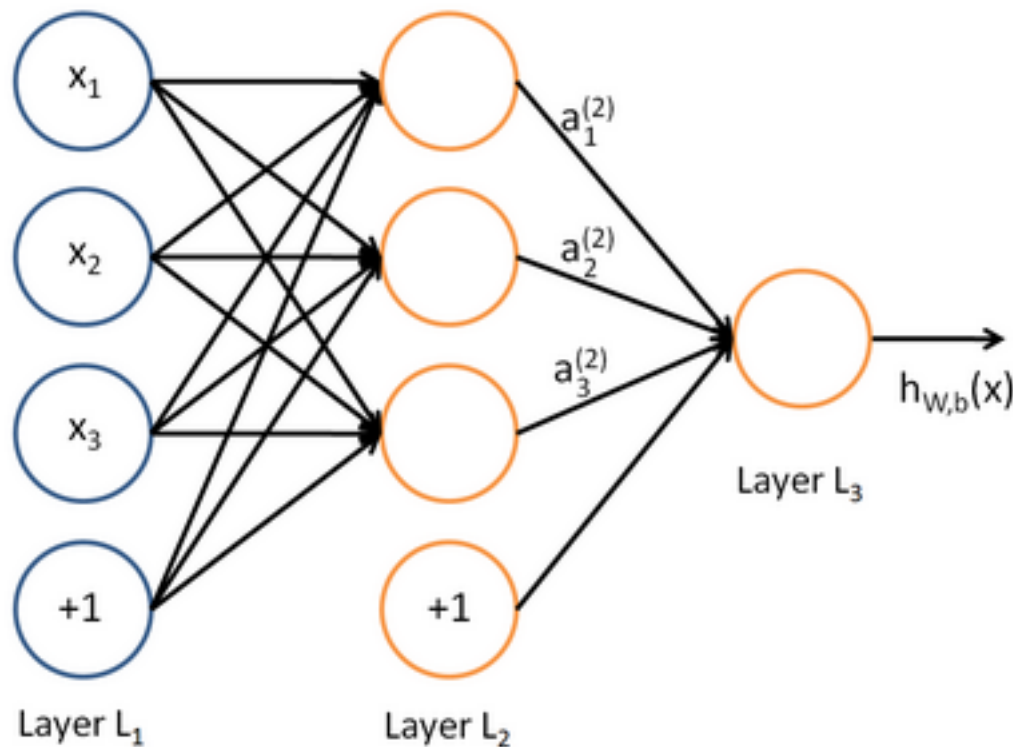

and it is the training criterion that will decide what those intermediate binary target variables should be, so as to make a good job of predicting the targets for the next layer, etc.

A neural network = running several logistic regressions at the same time

- Before we know it, we have a multilayer neural network....

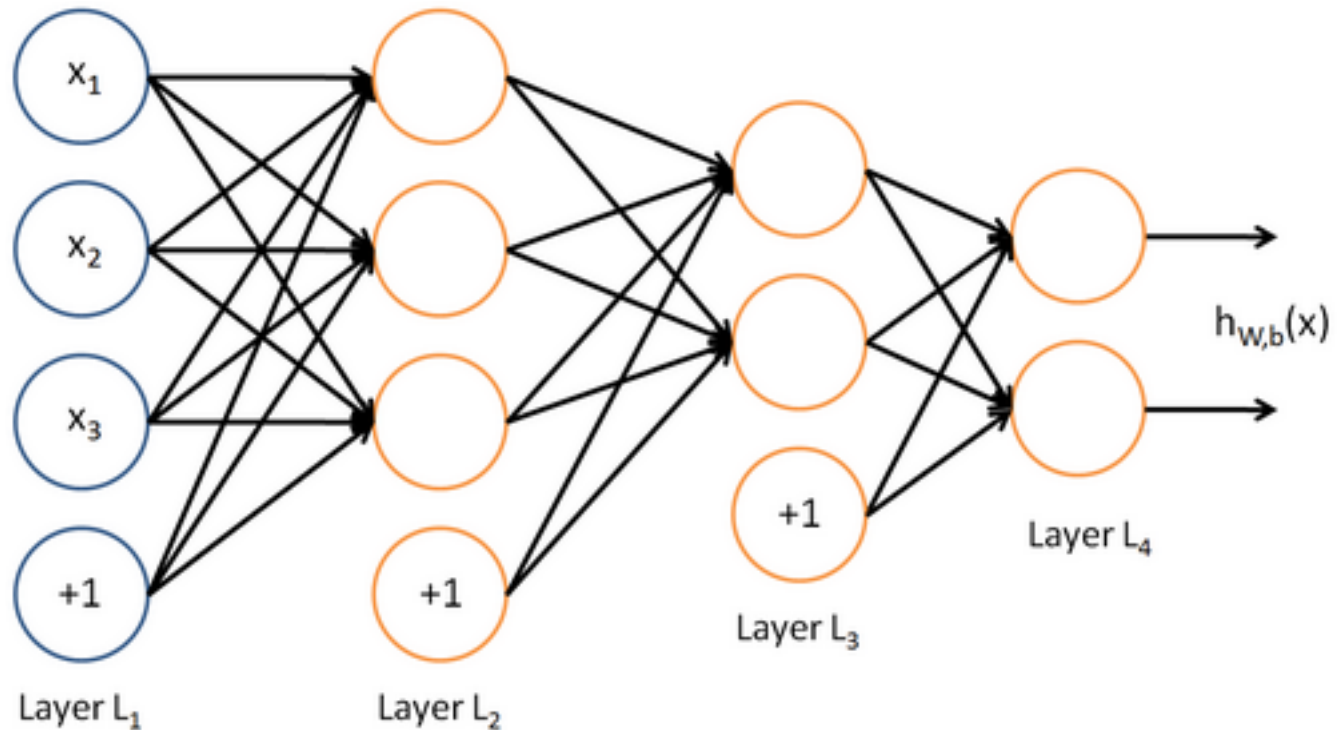

Back-Prop

- Compute gradient of example-wise loss wrt parameters

- Simply applying the derivative chain rule wisely

$$z = f(y) \quad y = g(x) \quad \frac{\partial z}{\partial x} = \frac{\partial z}{\partial y} \frac{\partial y}{\partial x}$$

- *If computing the loss(example, parameters) is $O(n)$ computation, then so is computing the gradient*

Simple Chain Rule

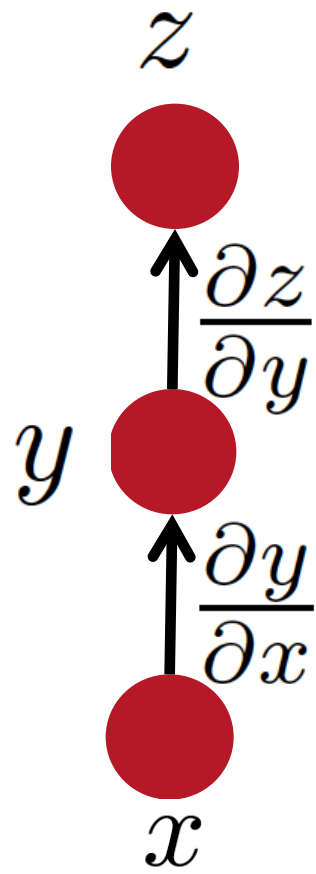

$$\Delta z = \frac{\partial z}{\partial y} \Delta y$$

$$\Delta y = \frac{\partial y}{\partial x} \Delta x$$

$$\Delta z = \frac{\partial z}{\partial y} \frac{\partial y}{\partial x} \Delta x$$

$$\frac{\partial z}{\partial x} = \frac{\partial z}{\partial y} \frac{\partial y}{\partial x}$$

Multiple Paths Chain Rule

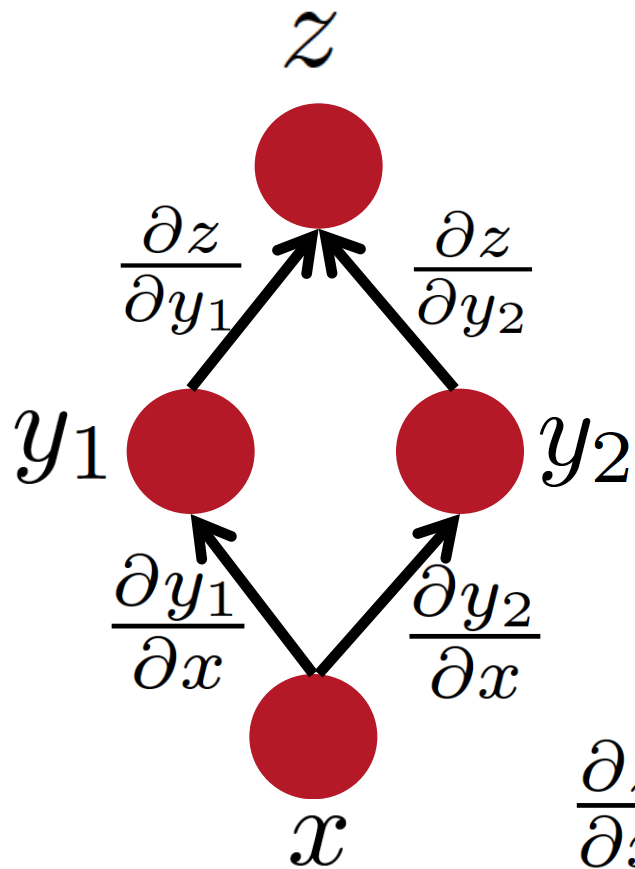

$$\frac{\partial z}{\partial x} = \frac{\partial z}{\partial y_1} \frac{\partial y_1}{\partial x} + \frac{\partial z}{\partial y_2} \frac{\partial y_2}{\partial x}$$

Multiple Paths Chain Rule - General

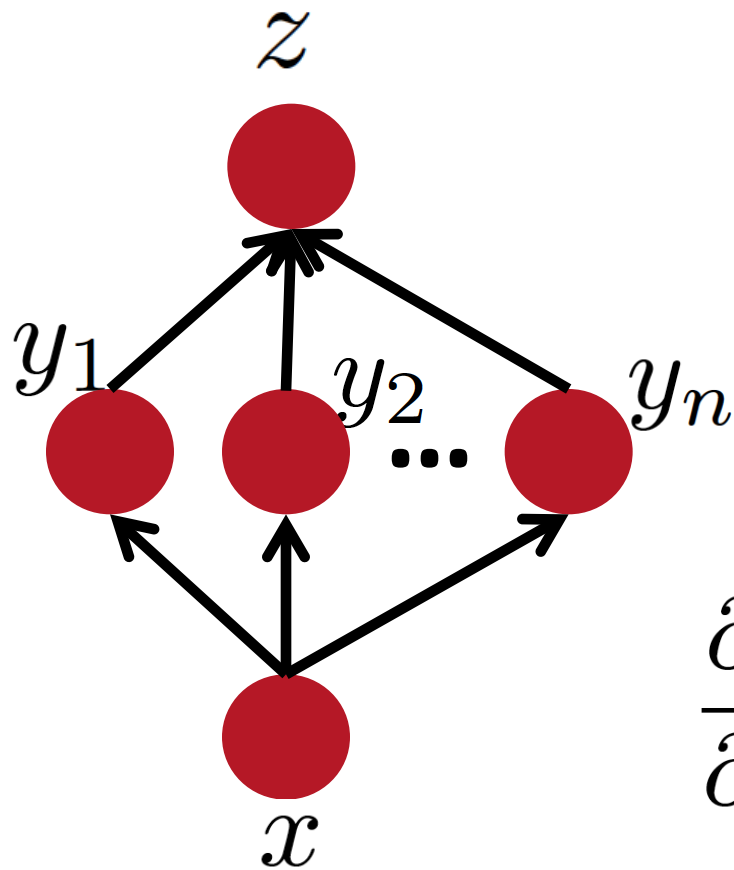

$$\frac{\partial z}{\partial x} = \sum_{i=1}^n \frac{\partial z}{\partial y_i} \frac{\partial y_i}{\partial x}$$

Chain Rule in Flow Graph

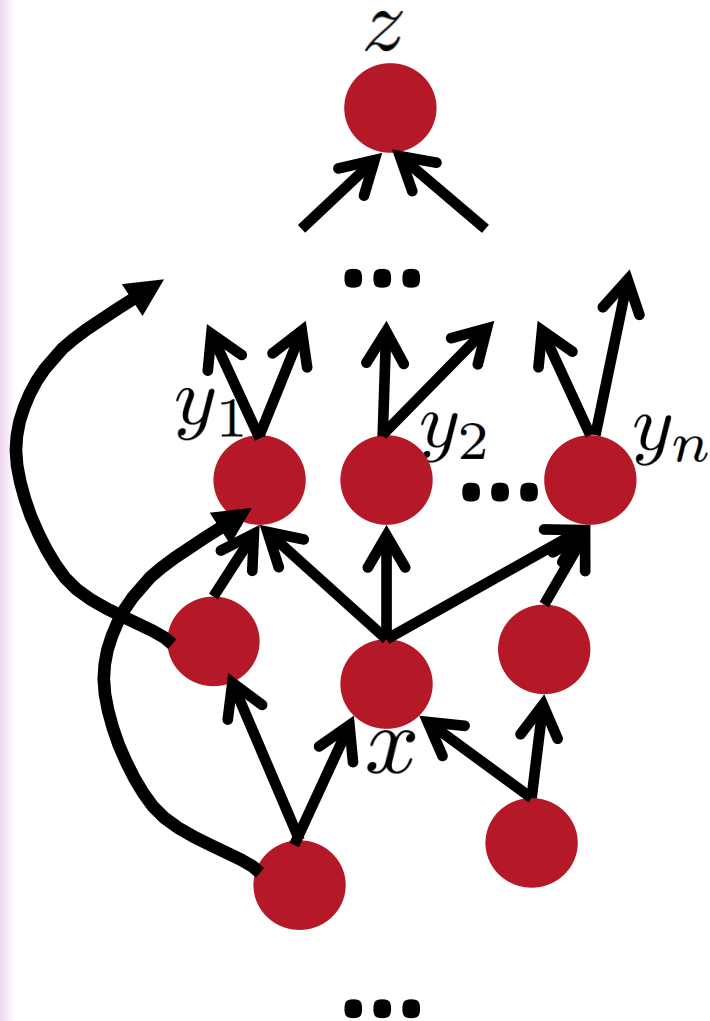

Flow graph: any directed acyclic graph
 node = computation result
 arc = computation dependency

$\{y_1, y_2, \dots, y_n\}$ = successors of x

$$\frac{\partial z}{\partial x} = \sum_{i=1}^n \frac{\partial z}{\partial y_i} \frac{\partial y_i}{\partial x}$$

Back-Prop in Multi-Layer Net

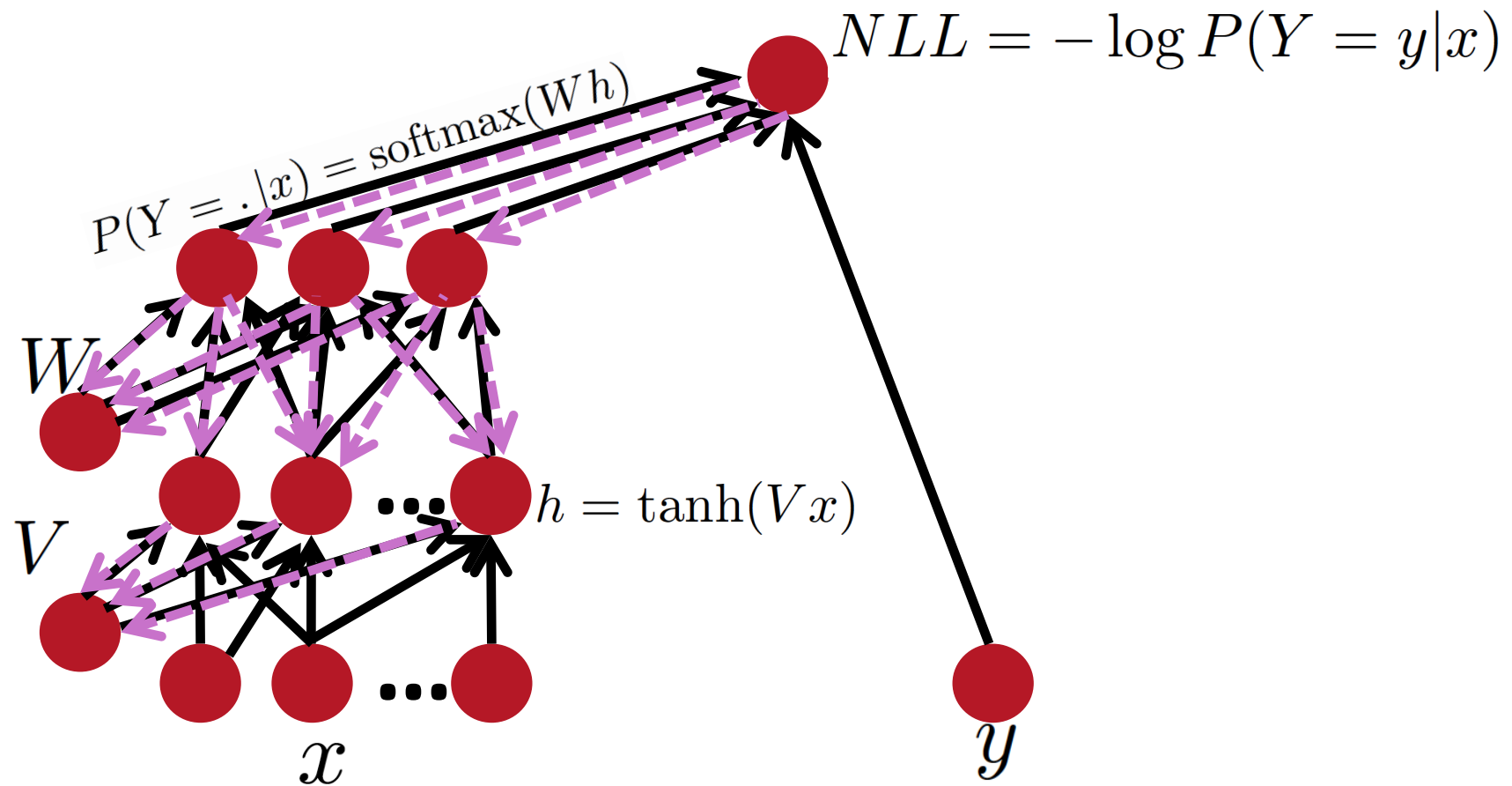

Back-Prop in General Flow Graph

Single scalar output z

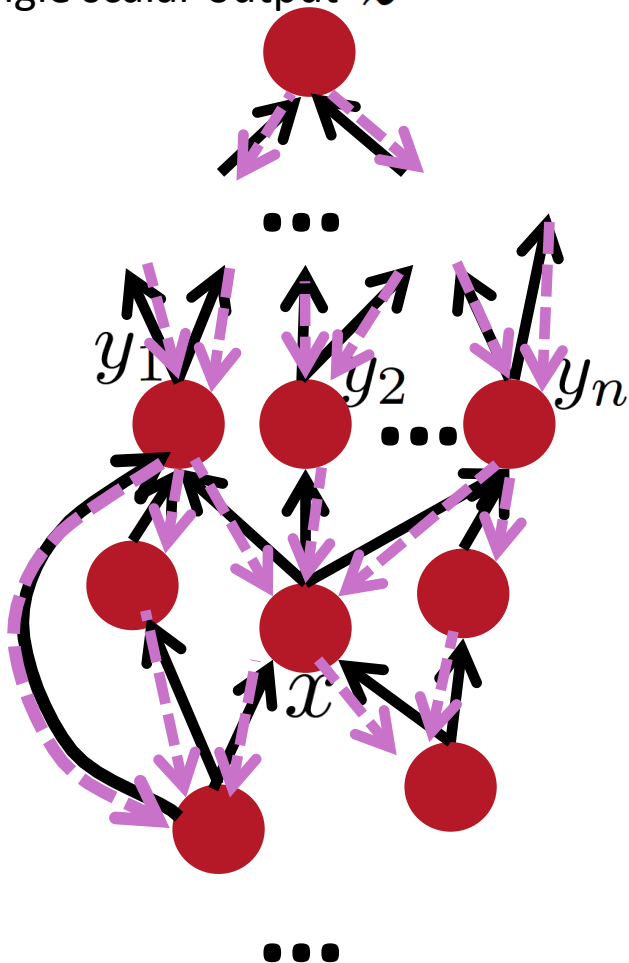

1. Fprop: visit nodes in topo-sort order
 - Compute value of node given predecessors
2. Bprop:
 - initialize output gradient = 1
 - visit nodes in reverse order:
 - Compute gradient wrt each node using gradient wrt successors

$\{y_1, y_2, \dots, y_n\}$ = successors of x

$$\frac{\partial z}{\partial x} = \sum_{i=1}^n \frac{\partial z}{\partial y_i} \frac{\partial y_i}{\partial x}$$

Back-Prop in Recurrent & Recursive Nets

- Replicate a parameterized function over different time steps or nodes of a DAG
- Output state at one time-step / node is used as input for another time-step / node

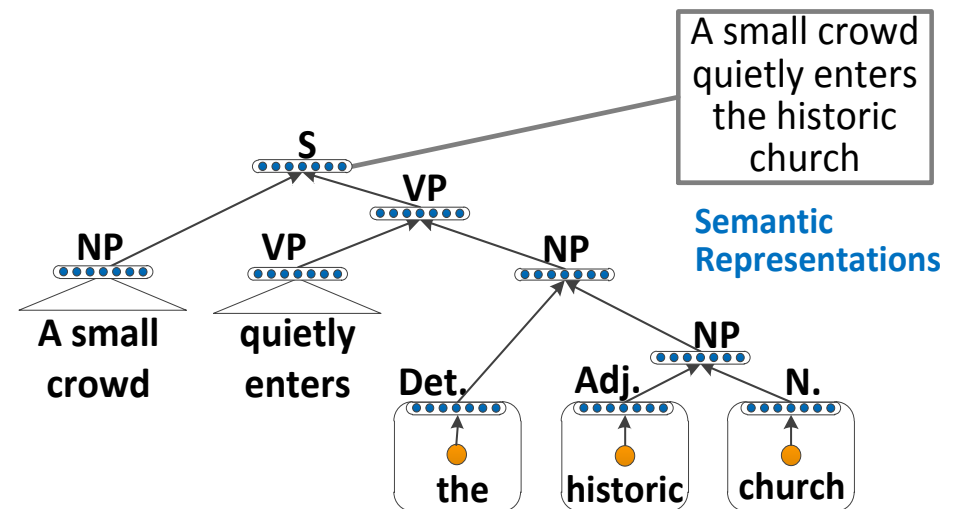
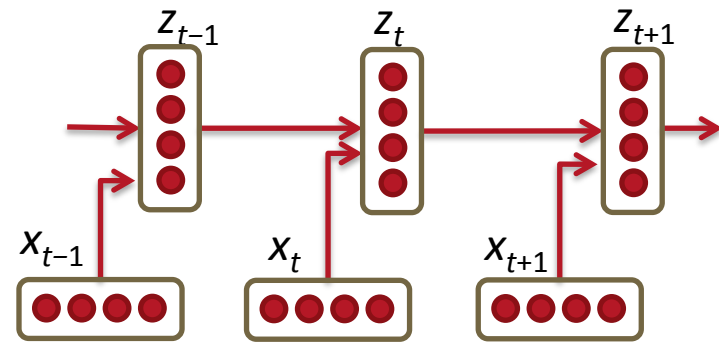

Backpropagation Through Structure

- Inference \rightarrow discrete choices
 - (e.g., shortest path in HMM, best output configuration in CRF)
- E.g. Max over configurations or sum weighted by posterior
- The loss to be optimized depends on these choices
- The inference operations are flow graph nodes
- If continuous, can perform stochastic gradient descent
 - $\text{Max}(a,b)$ is continuous.

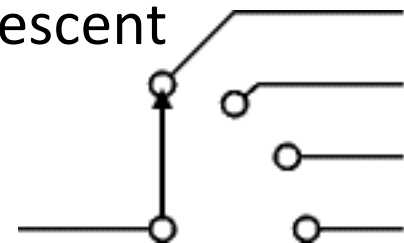

Automatic Differentiation

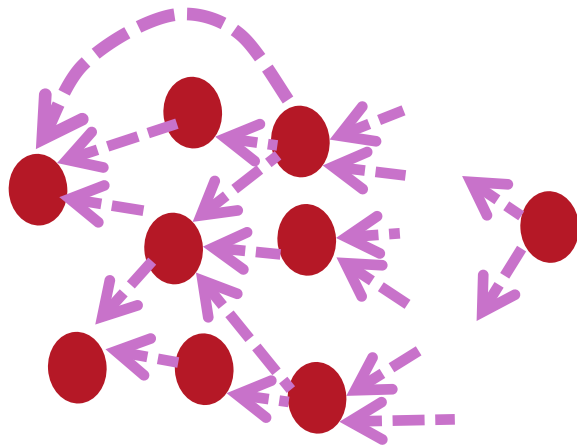
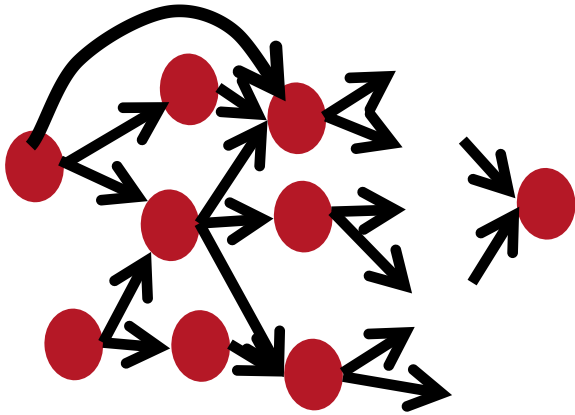

- The gradient computation can be automatically inferred from the symbolic expression of the fprop.
- Each node type needs to know how to compute its output and how to compute the gradient wrt its inputs given the gradient wrt its output.
- Easy and fast prototyping

Deep Supervised Neural Nets

- We can now train them even without unsupervised pre-training, thanks to better initialization and non-linearities (rectifiers, maxout) and they can generalize well with large labeled sets and dropout.
- Unsupervised pre-training still useful for rare classes, transfer, smaller labeled sets, or as an extra regularizer.

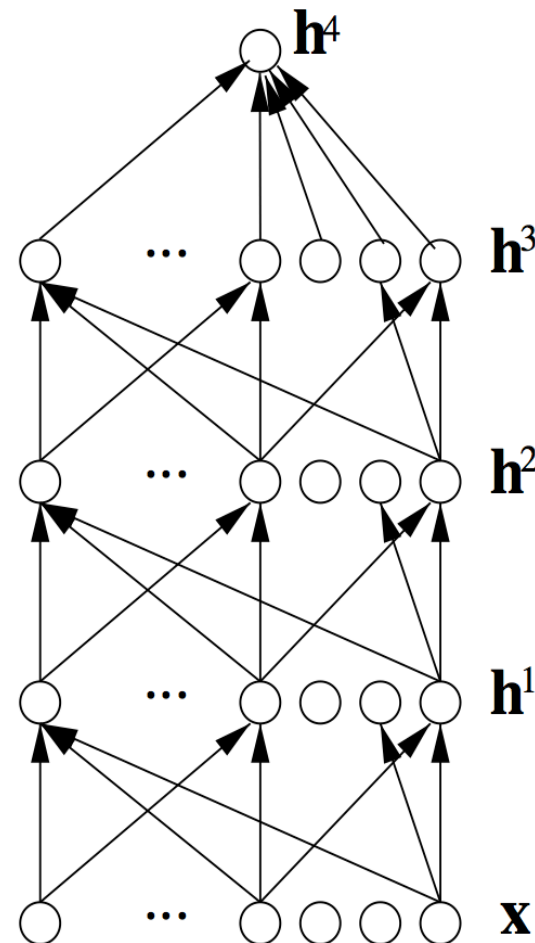

Stochastic Neurons as Regularizer:

Improving neural networks by preventing co-adaptation of feature detectors (Hinton et al 2012, arXiv)

- **Dropouts** trick: during training multiply neuron output by random bit ($p=0.5$), during test by 0.5
- Used in deep supervised networks
- Similar to denoising auto-encoder, but corrupting every layer
- Works better with some non-linearities (rectifiers, maxout)
(Goodfellow et al. ICML 2013)
- Equivalent to averaging over exponentially many architectures
 - Used by Krizhevsky et al to break through ImageNet SOTA
 - Also improves SOTA on CIFAR-10 (18 \rightarrow 16% err)
 - Knowledge-free MNIST with DBMs (.95 \rightarrow .79% err)
 - TIMIT phoneme classification (22.7 \rightarrow 19.7% err)

Dropout Regularizer: Super-Efficient Bagging

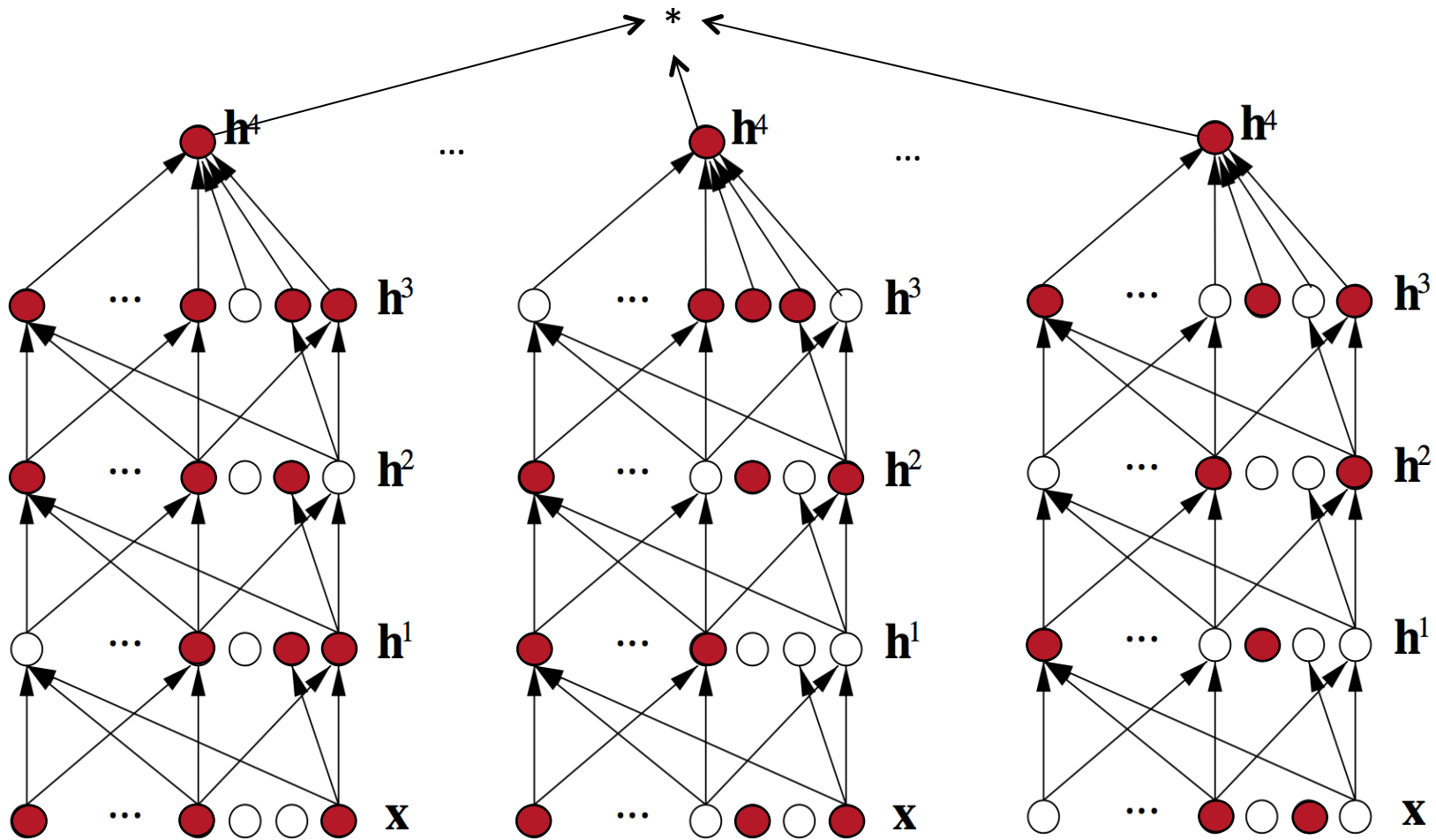

Temporal & Spatial Inputs: Convolutional & Recurrent Nets

- Local connectivity across time/space
- Sharing weights across time/space (translation equivariance)
- Pooling (translation invariance, cross-channel pooling for learned invariances)

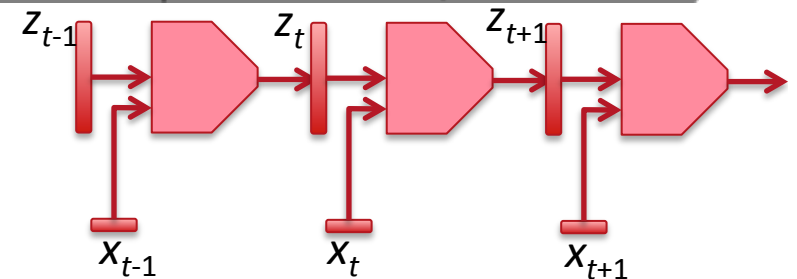
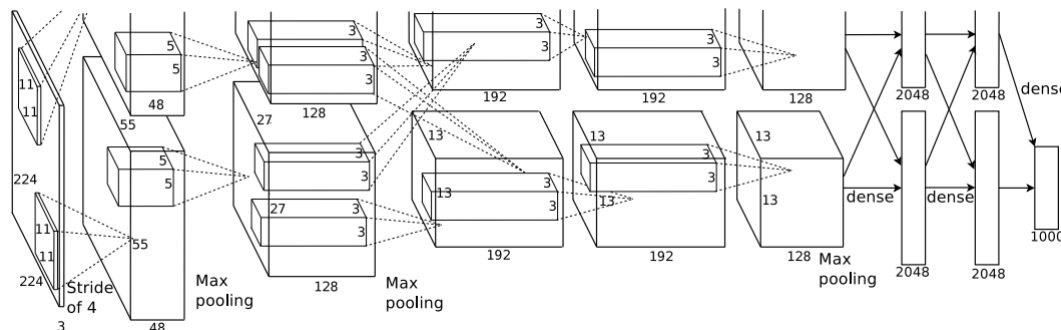
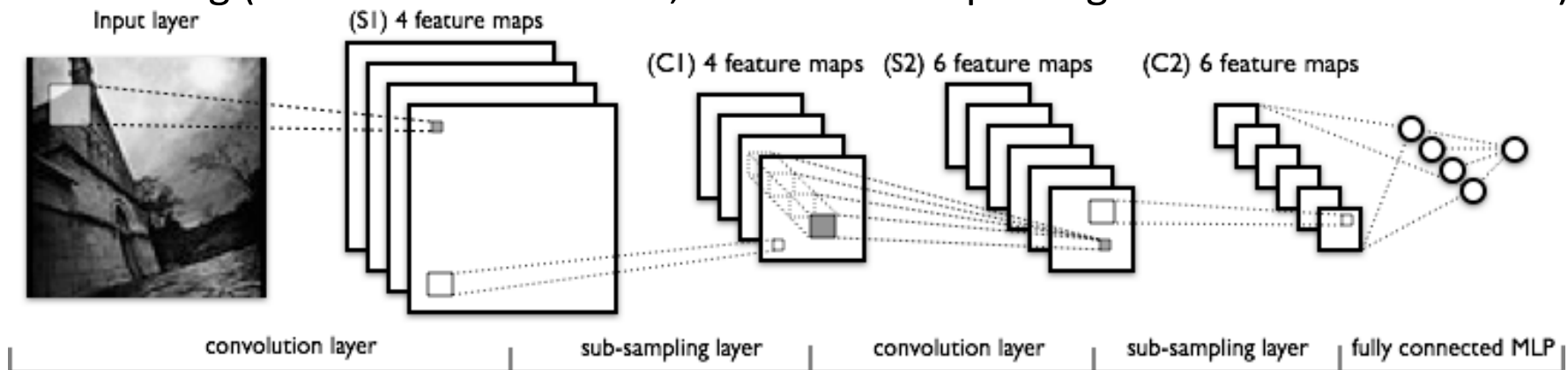

Recurrent nets (RNNs) can summarize information from the past

Bidirectional RNNs also summarize information from the future

Distributed Representations
& Neural Nets:

How to do **unsupervised**
training?

PCA

= Linear Manifold
 = Linear Auto-Encoder
 = Linear Gaussian Factors

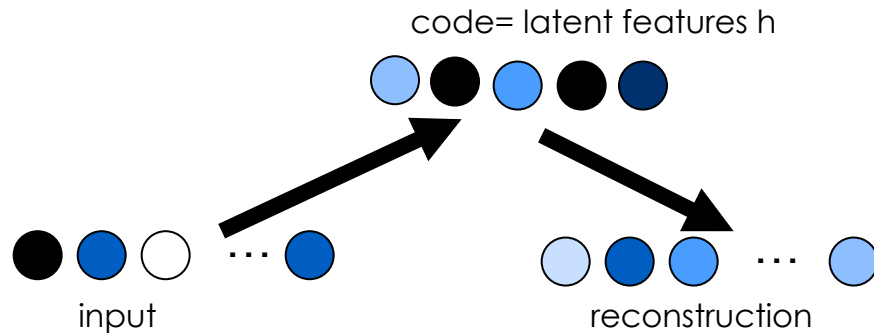

input x , 0-mean
 features=code= $h(x)=W x$
 reconstruction(x)= $W^T h(x) = W^T W x$
 W = principal eigen-basis of $Cov(X)$

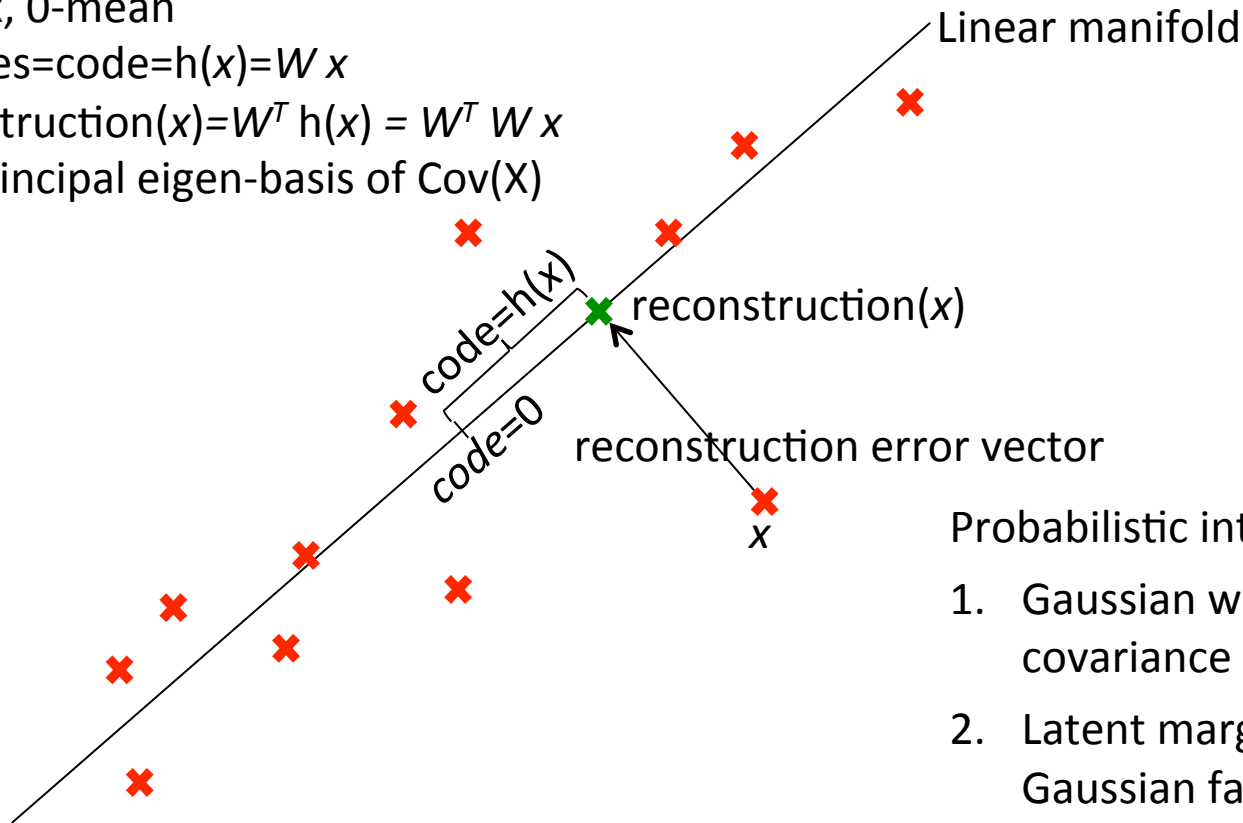

Probabilistic interpretations:

1. Gaussian with full covariance $W^T W + \lambda I$
2. Latent marginally iid Gaussian factors h with $x = W^T h + noise$

Directed Factor Models:

$$P(x, h) = P(h) P(x|h)$$

factors prior likelihood

- $P(h)$ factorizes into $P(h_1) P(h_2) \dots$
- Different priors:
 - PCA: $P(h_i)$ is Gaussian
 - ICA: $P(h_i)$ is non-parametric
 - **Sparse coding**: $P(h_i)$ is concentrated near 0
- Likelihood is typically Gaussian $x | h$ with mean given by $W^T h$
- **Inference** procedures (predicting h , given x) differ
- Sparse h : x is explained by the weighted addition of selected filters h_i

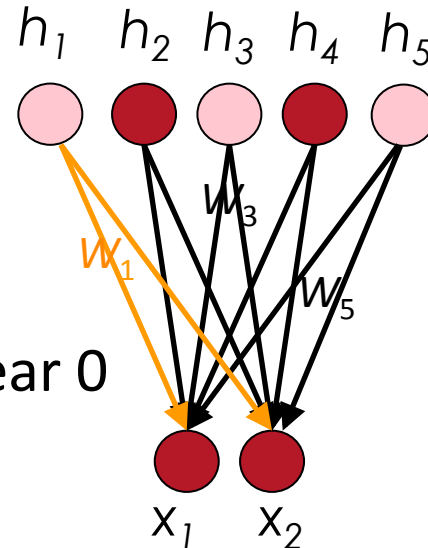

$$\begin{array}{c} x \\ \boxed{\text{Graph of } x} \end{array} = h_1 \begin{array}{c} W_1 \\ \boxed{\text{Graph of } W_1} \end{array} + h_3 \begin{array}{c} W_3 \\ \boxed{\text{Graph of } W_3} \end{array} + h_5 \begin{array}{c} W_5 \\ \boxed{\text{Graph of } W_5} \end{array}$$

The equation shows a target signal x (a triangular wave) being decomposed into a sparse representation using three filters: W_1 (a rising ramp), W_3 (a flat line with a slight rise), and W_5 (a falling ramp). The weights are $h_1 = 0.9$, $h_3 = 0.8$, and $h_5 = 0.7$.

Sparse autoencoder illustration for images

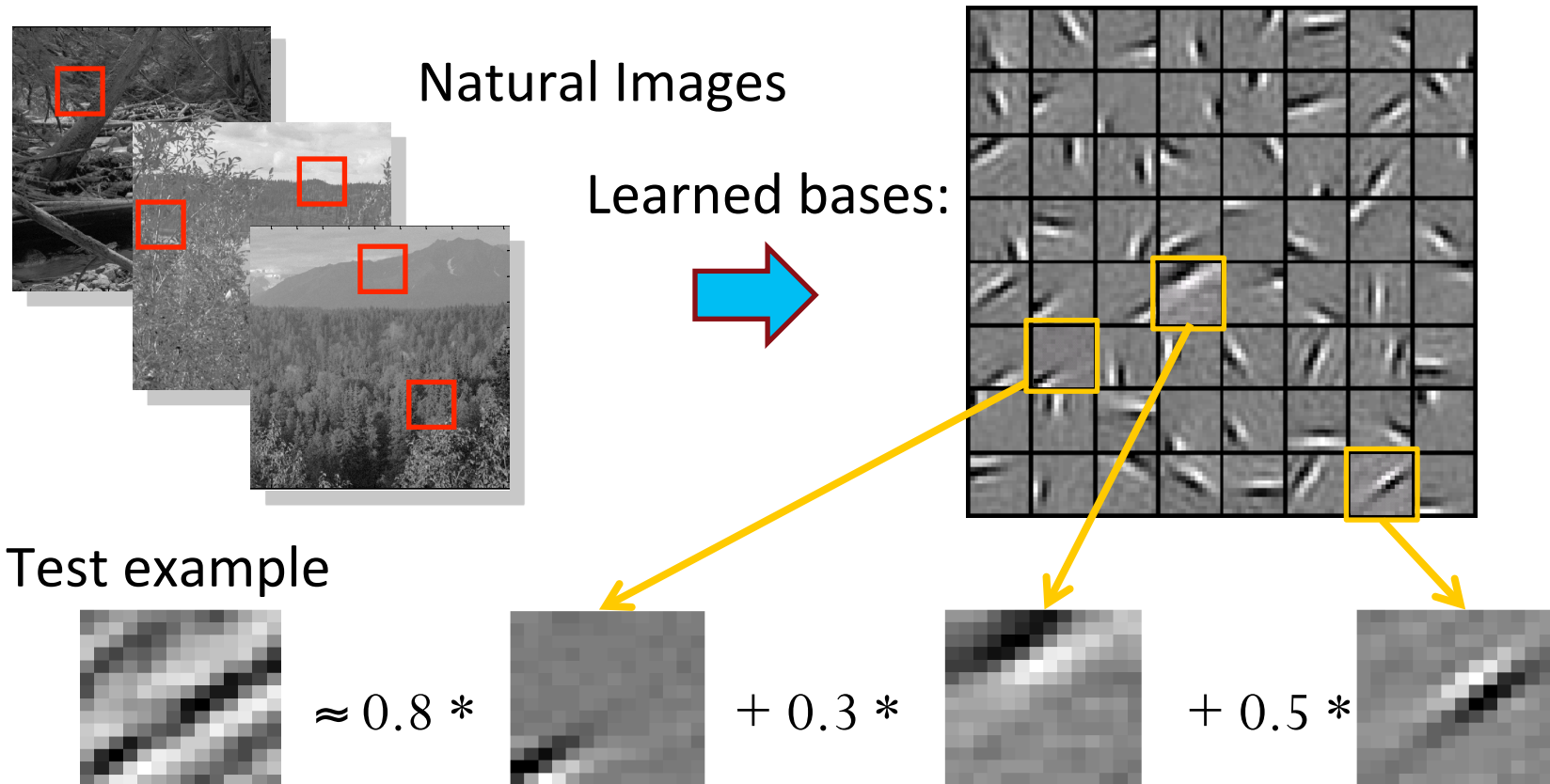

$$[h_1, \dots, h_{64}] = [0, 0, \dots, 0, \mathbf{0.8}, 0, \dots, 0, \mathbf{0.3}, 0, \dots, 0, \mathbf{0.5}, 0]$$

(feature representation)

Stacking Single-Layer Learners

- PCA is great but can't be stacked into deeper more abstract representations (linear \times linear = linear)
- One of the big ideas from Hinton et al. 2006: layer-wise unsupervised feature learning

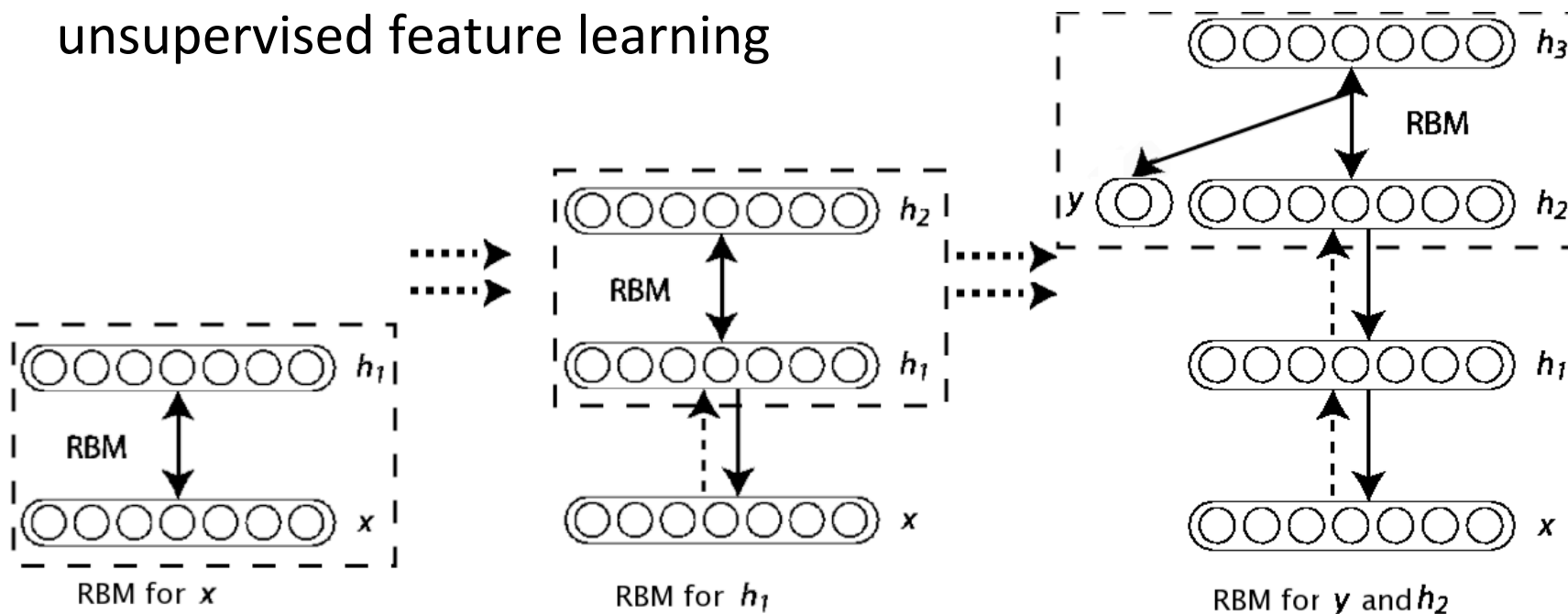

Stacking Restricted Boltzmann Machines (RBM) \rightarrow Deep Belief Network (DBN)

Effective deep Learning first became possible with unsupervised pre-training

[Erhan et al., JMLR 2010]



(with RBMs and Denoising Auto-Encoders)

Purely supervised neural net

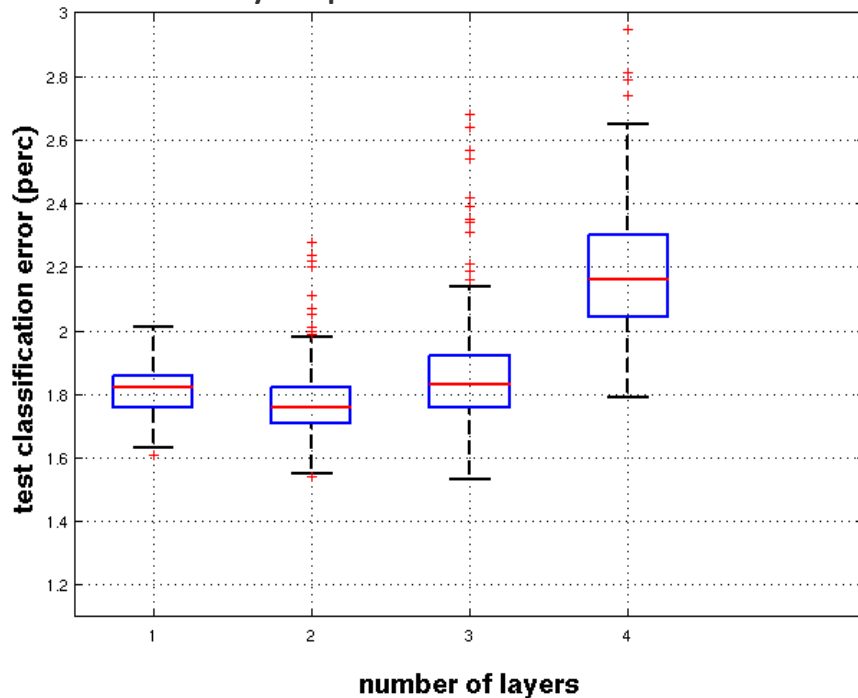

With unsupervised pre-training

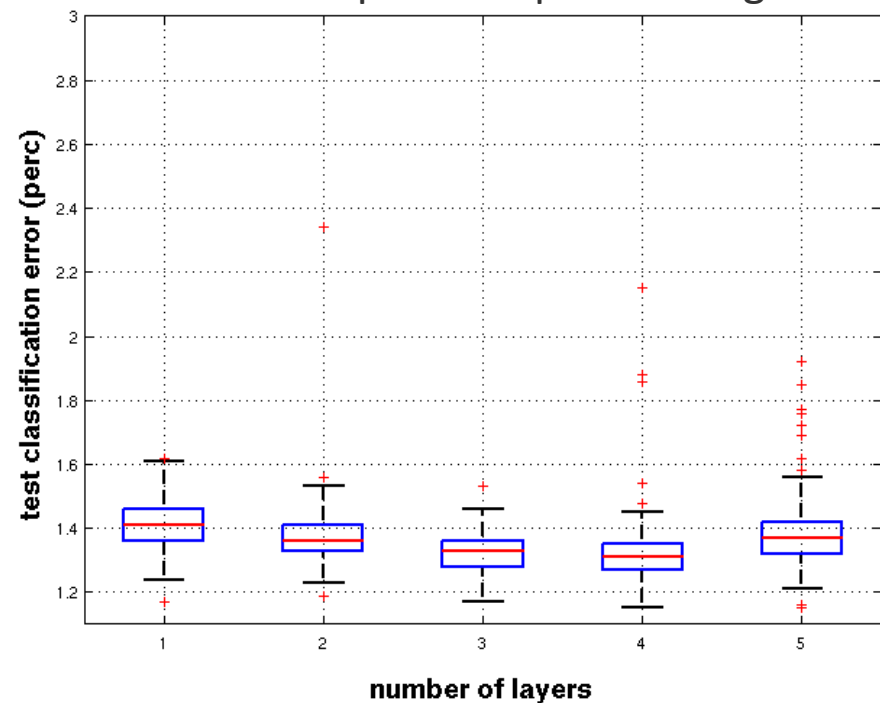

Optimizing Deep Non-Linear Composition of Functions Seems Hard

- Failure of training deep supervised nets before 2006
- Regularization effect vs optimization effect of unsupervised pre-training
- Is optimization difficulty due to
 - ill-conditioning?
 - local minima?
 - both?
- The jury is still out, but we now have success stories of training deep supervised nets without unsupervised pre-training

Initial Examples Matter More (critical period?)

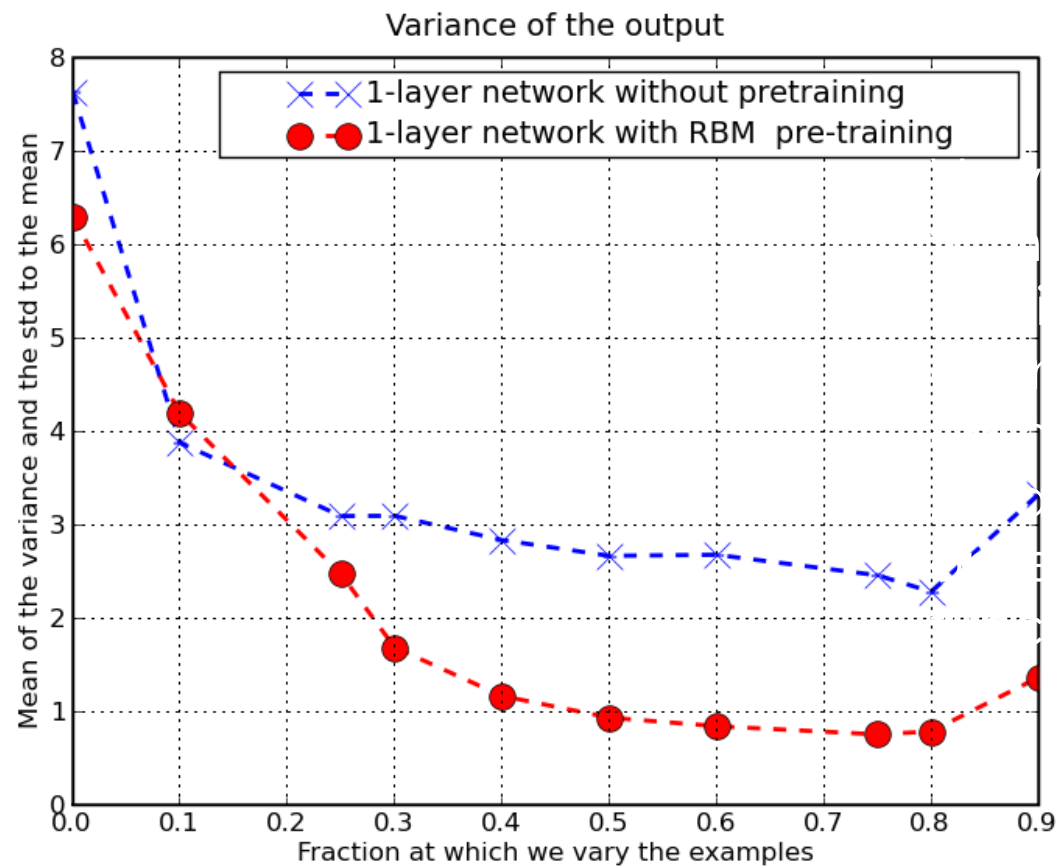

Order & Selection of Examples Matters

(Bengio, Louradour, Collobert & Weston, ICML'2009)



- Curriculum learning
 - (Bengio et al 2009, Krueger & Dayan 2009)
 - **Start with easier examples**
- Faster convergence to a better local minimum in deep architectures

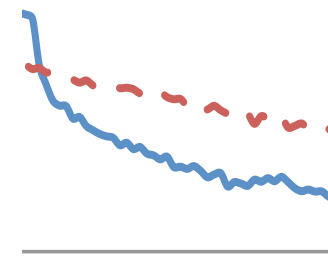

— curriculum
- - no-curriculum

Understanding the difficulty of training deep feedforward neural networks

(Glorot & Bengio, AISTATS 2010)



Study the activations and gradients

- wrt depth
- as training progresses
- for **different initializations** → big difference
- for **different non-linearities** → big difference

First demonstration that deep supervised nets can be successfully trained almost as well as with unsupervised pre-training, by setting up the optimization problem appropriately...

Layer-wise Unsupervised Learning

input ● ● ● ... ●

Layer-Wise Unsupervised Pre-training

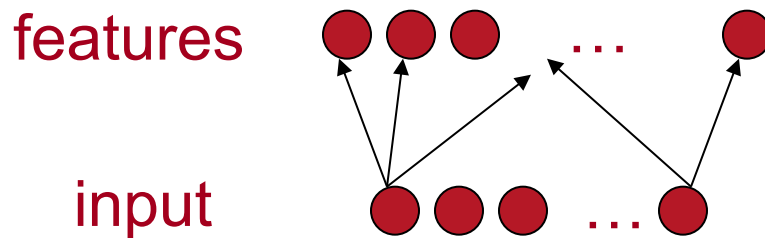

Layer-Wise Unsupervised Pre-training

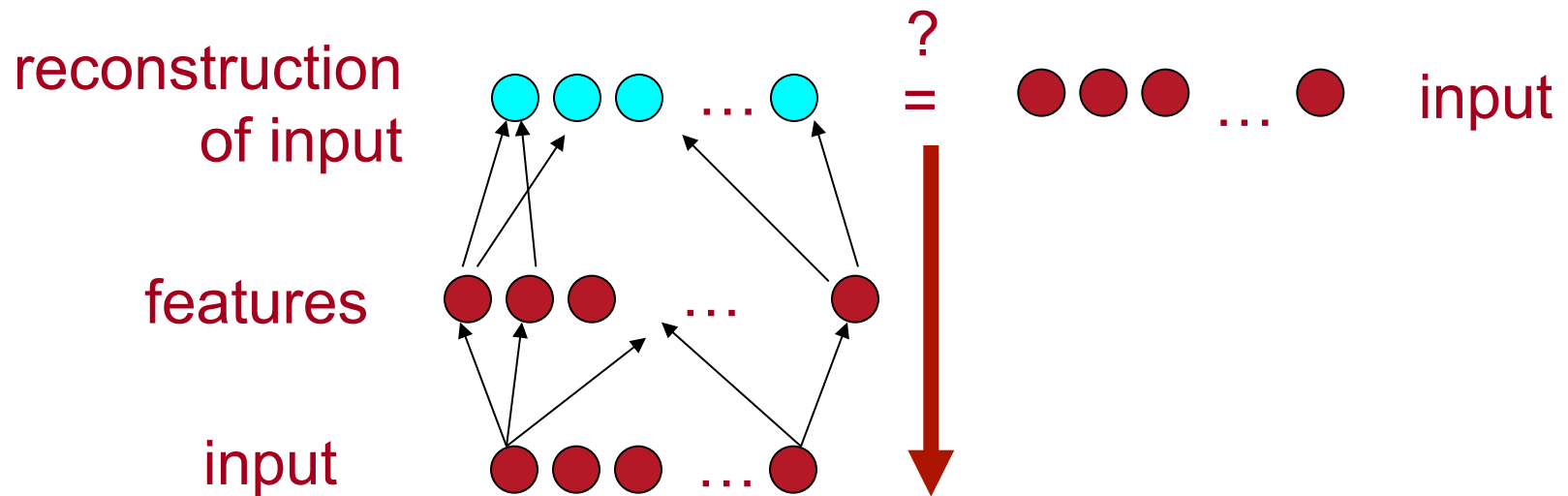

Layer-Wise Unsupervised Pre-training

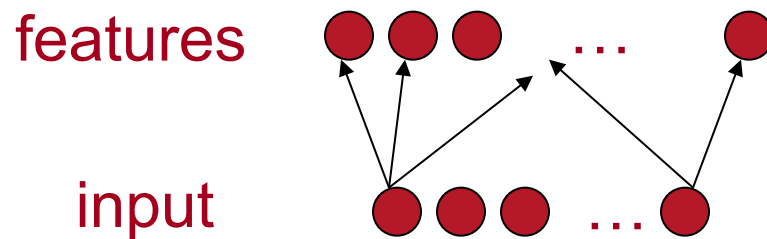

Layer-Wise Unsupervised Pre-training

More abstract
features

features

input

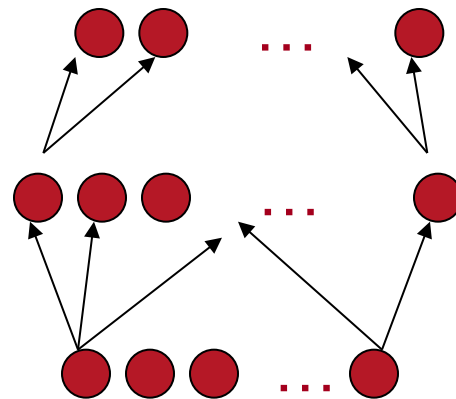

Layer-wise Unsupervised Learning

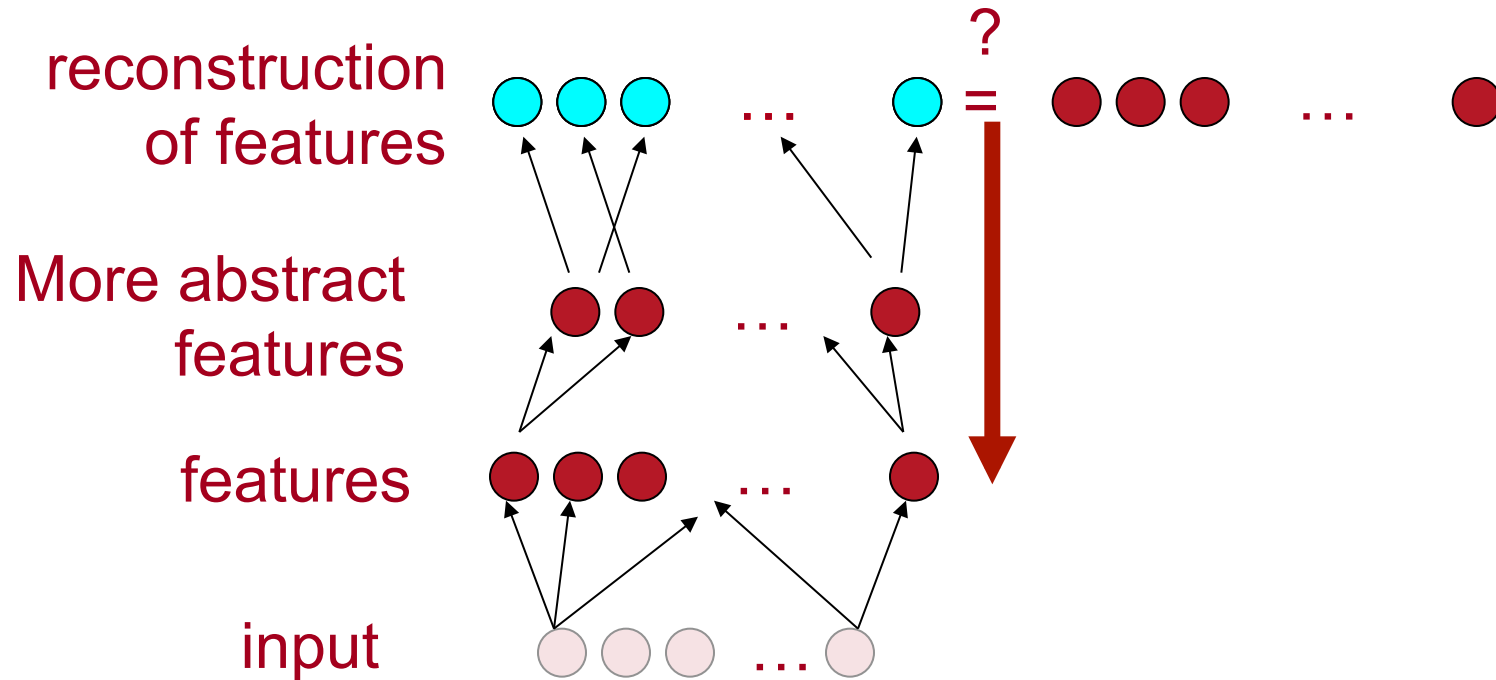

Layer-Wise Unsupervised Pre-training

More abstract
features

features

input

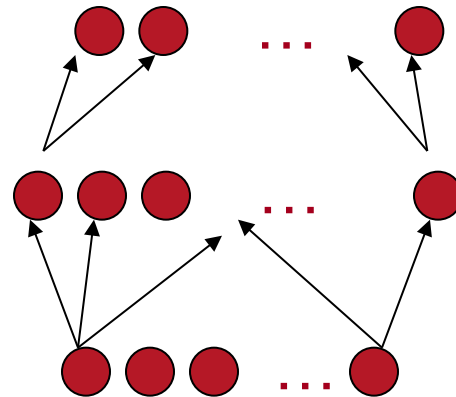

Layer-wise Unsupervised Learning

Even more abstract
features

More abstract
features

features

input

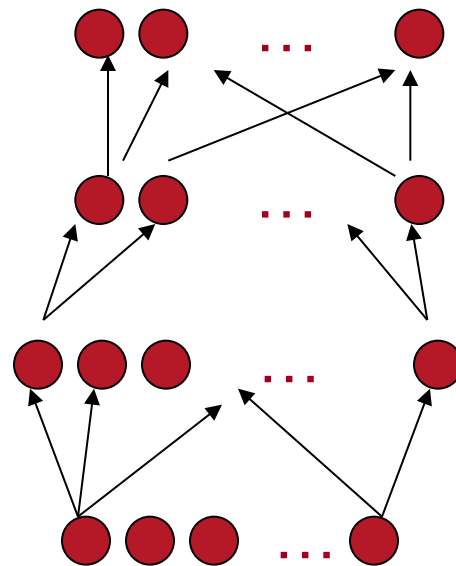

Supervised Fine-Tuning

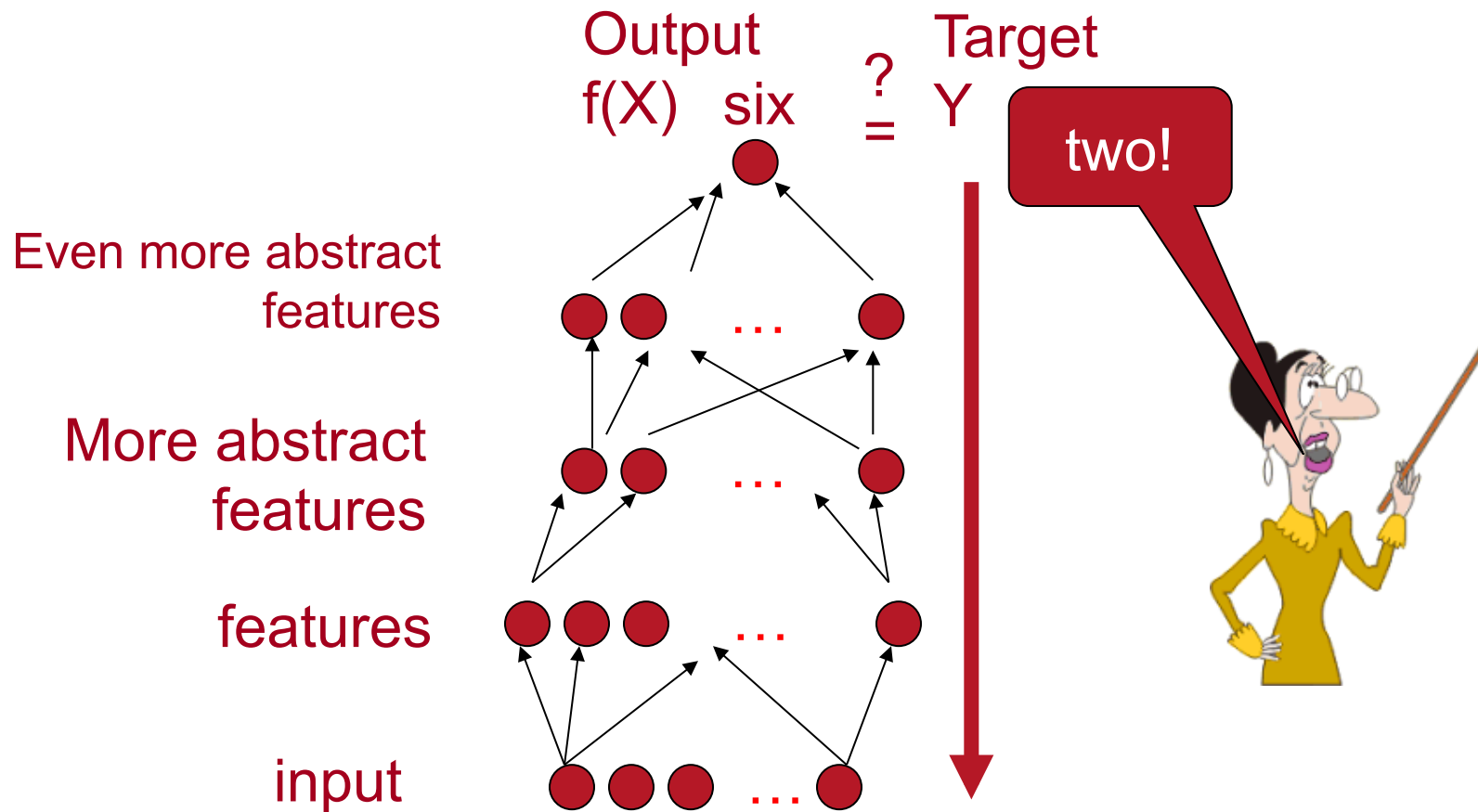

- Additional hypothesis: features good for $P(x)$ good for $P(y|x)$

Restricted Boltzmann Machines

Undirected Models: the Restricted Boltzmann Machine

[Hinton et al 2006]



- Probabilistic model of the joint distribution of the observed variables (inputs alone or inputs and targets) x
- Latent (hidden) variables h model high-order dependencies
- Inference is easy, $P(h|x)$ factorizes into product of $P(h_i | x)$
- See Bengio (2009) detailed monograph/review: *“Learning Deep Architectures for AI”*.
- See Hinton (2010) *“A practical guide to training Restricted Boltzmann Machines”*

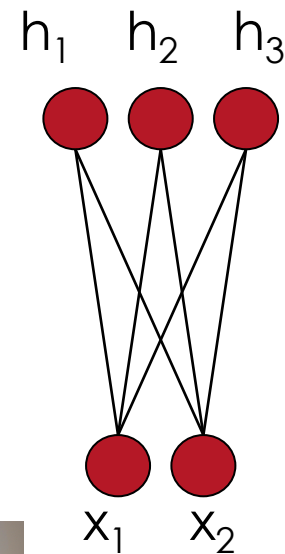

Boltzmann Machines & MRFs

- Boltzmann machines:

(Hinton 84)
$$P(x) = \frac{1}{Z} e^{-\text{Energy}(x)} = \frac{1}{Z} e^{c^T x + x^T W x} = \frac{1}{Z} e^{\sum_i c_i x_i + \sum_{i,j} x_i W_{ij} x_j}$$

- Markov Random Fields:

$$P(x) = \frac{1}{Z} e^{\sum_i w_i f_i(x)}$$

Soft constraint / probabilistic statement

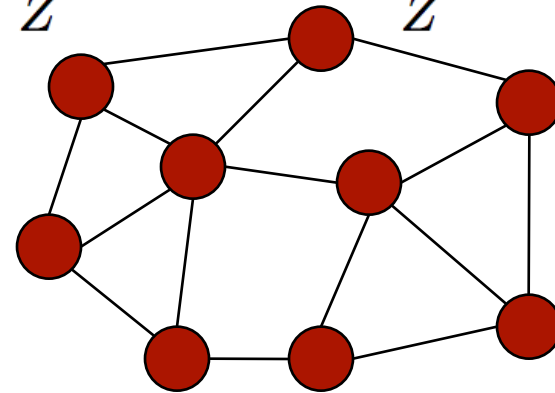

Undirected
graphical
models

- More interesting with latent variables!

Restricted Boltzmann Machine (RBM)

$$P(x, h) = \frac{1}{Z} e^{b^T h + c^T x + h^T W x} = \frac{1}{Z} e^{\sum_i b_i h_i + \sum_j c_j x_j + \sum_{i,j} h_i W_{ij} x_j}$$

- A popular building block for deep architectures
- **Bipartite** undirected graphical model

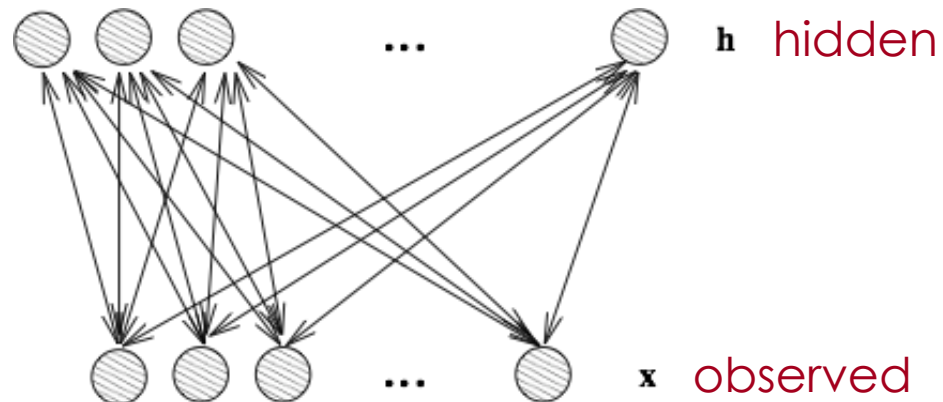

Gibbs Sampling & Block Gibbs Sampling

- Want to sample from $P(X_1, X_2, \dots, X_n)$
- **Gibbs sampling**
 - Iterate or randomly choose i in $\{1 \dots n\}$
 - Sample X_i from $P(X_i | X_1, X_2, \dots, X_{i-1}, X_{i+1}, \dots, X_n)$

can only make small changes at a time! → **slow mixing**

Note how fixed point samples from the joint.

Special case of Metropolis-Hastings.

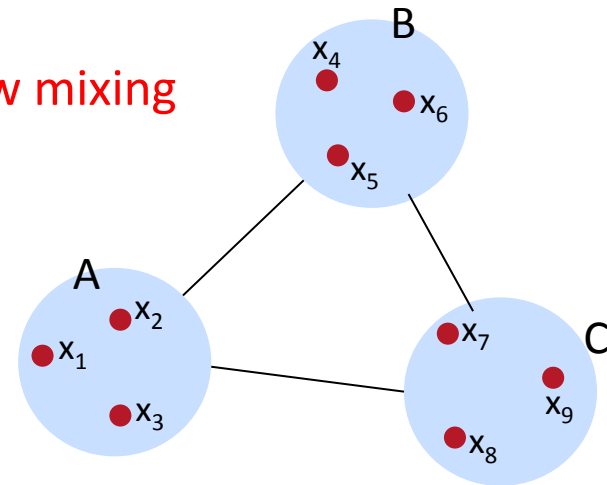

- **Block Gibbs sampling** (not always possible)
 - X's organized in blocks, e.g. $A=(X_1, X_2, X_3)$, $B=(X_4, X_5, X_6)$, $C=...$
 - Do Gibbs on $P(A, B, C, \dots)$, i.e.
 - Sample A from $P(A | B, C)$
 - Sample B from $P(B | A, C)$
 - Sample C from $P(C | A, B)$, and iterate...
 - Larger changes → **faster mixing**

Block Gibbs Sampling in RBMs

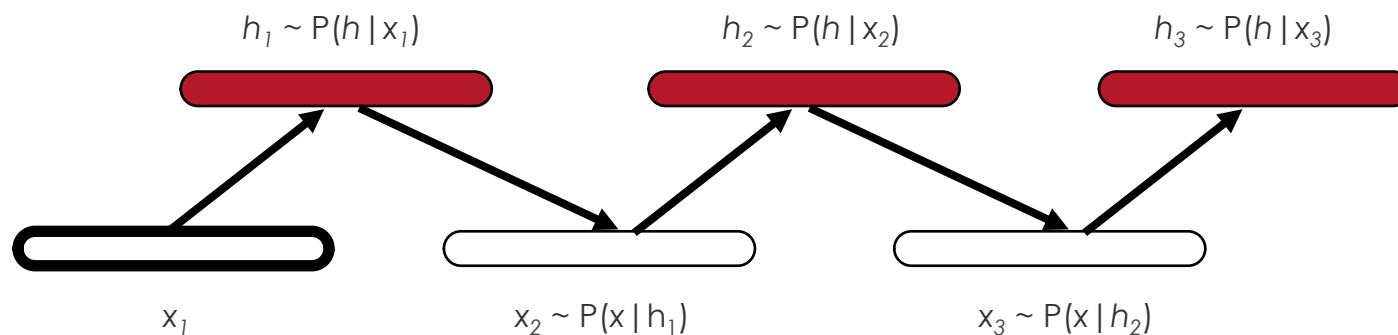

$P(h|x)$ and $P(x|h)$ factorize

$$P(h|x) = \prod_i P(h_i|x)$$

- Easy inference
- Efficient **block Gibbs** sampling $x \rightarrow h \rightarrow x \rightarrow h \dots$

$$P(x, h) = \frac{1}{Z} e^{b^T h + c^T x + h^T W x}$$

Obstacle: Vicious Circle Between Learning and MCMC Sampling

- Early during training, density smeared out, mode bumps overlap

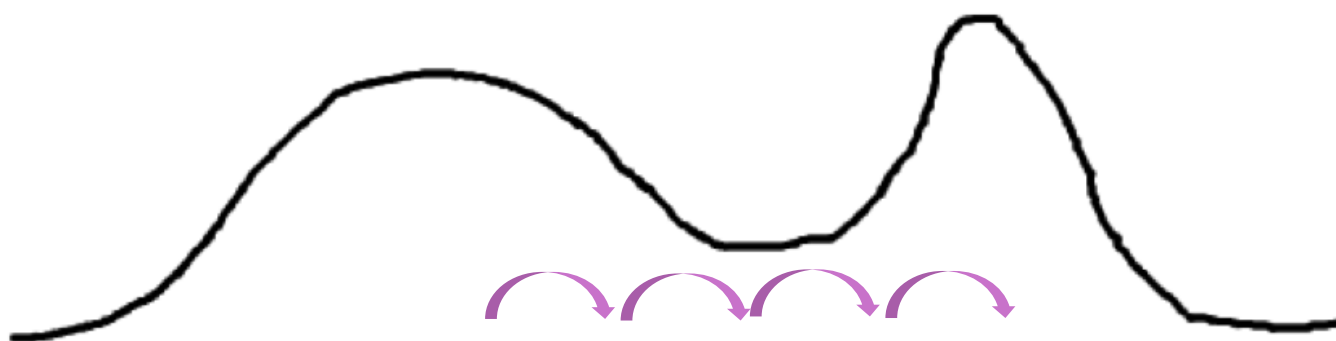

- Later on, hard to cross empty voids between modes

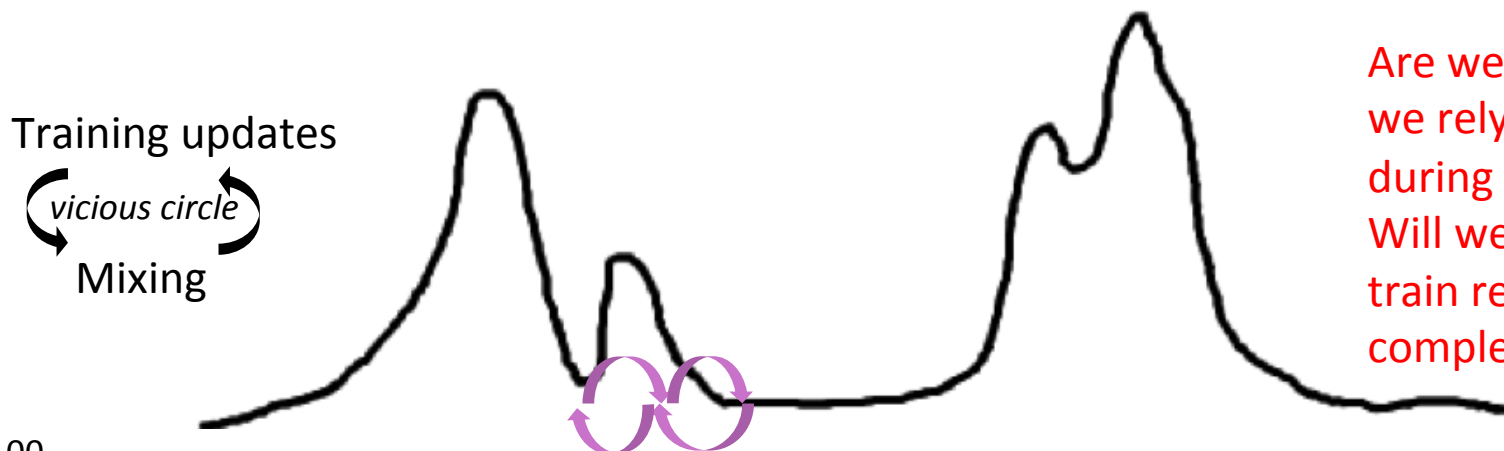

Are we doomed if we rely on MCMC during training?
Will we be able to train really large & complex models?

RBM with (image, Label) visible units

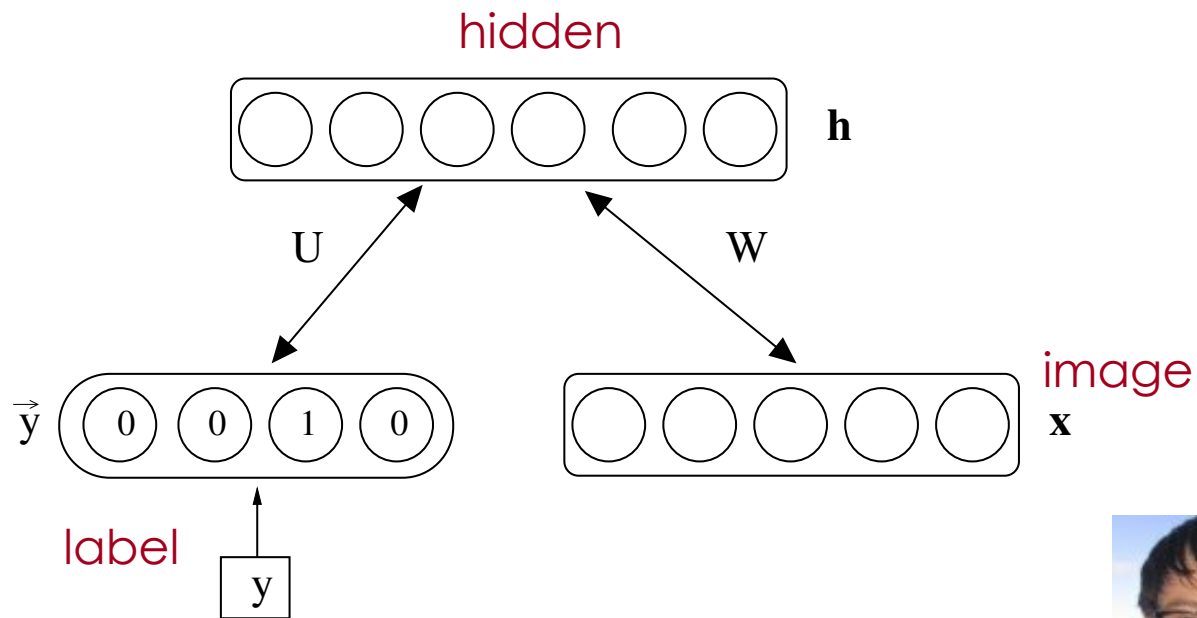

(Larochelle & Bengio 2008)

RBMs are Universal Approximators

(Le Roux & Bengio 2008)



- Adding one hidden unit (with proper choice of parameters) guarantees increasing likelihood
- With enough hidden units, can perfectly model any discrete distribution
- RBMs with variable # of hidden units = non-parametric

RBM Conditionals Factorize

$$\begin{aligned} P(\mathbf{h}|\mathbf{x}) &= \frac{\exp(\mathbf{b}'\mathbf{x} + \mathbf{c}'\mathbf{h} + \mathbf{h}'W\mathbf{x})}{\sum_{\tilde{\mathbf{h}}} \exp(\mathbf{b}'\mathbf{x} + \mathbf{c}'\tilde{\mathbf{h}} + \tilde{\mathbf{h}}'W\mathbf{x})} \\ &= \frac{\prod_i \exp(\mathbf{c}_i\mathbf{h}_i + \mathbf{h}_iW_i\mathbf{x})}{\prod_i \sum_{\tilde{\mathbf{h}}_i} \exp(\mathbf{c}_i\tilde{\mathbf{h}}_i + \tilde{\mathbf{h}}_iW_i\mathbf{x})} \\ &= \prod_i \frac{\exp(\mathbf{h}_i(\mathbf{c}_i + W_i\mathbf{x}))}{\sum_{\tilde{\mathbf{h}}_i} \exp(\tilde{\mathbf{h}}_i(\mathbf{c}_i + W_i\mathbf{x}))} \\ &= \prod_i P(\mathbf{h}_i|\mathbf{x}). \end{aligned}$$

RBM Energy Gives Binomial Neurons

With $\mathbf{h}_i \in \{0, 1\}$, recall $\text{Energy}(\mathbf{x}, \mathbf{h}) = -\mathbf{b}'\mathbf{x} - \mathbf{c}'\mathbf{h} - \mathbf{h}'W\mathbf{x}$

$$\begin{aligned} P(\mathbf{h}_i = 1|\mathbf{x}) &= \frac{e^{1\mathbf{c}_i + 1W_i\mathbf{x} + \text{other terms}}}{e^{1\mathbf{c}_i + 1W_i\mathbf{x} + \text{other terms}} + e^{0\mathbf{c}_i + 0W_i\mathbf{x} + \text{other terms}}} \\ &= \frac{e^{\mathbf{c}_i + W_i\mathbf{x}}}{e^{\mathbf{c}_i + W_i\mathbf{x}} + 1} \\ &= \frac{1}{1 + e^{-\mathbf{c}_i - W_i\mathbf{x}}} \\ &= \text{sigm}(\mathbf{c}_i + W_i\mathbf{x}). \end{aligned}$$

since $\text{sigm}(a) = \frac{1}{1+e^{-a}}$.

RBM Free Energy

$$P(\mathbf{x}, \mathbf{h}) = \frac{e^{-\text{Energy}(\mathbf{x}, \mathbf{h})}}{Z}$$

- Free Energy = equivalent energy when marginalizing

$$P(\mathbf{x}) = \sum_{\mathbf{h}} \frac{e^{-\text{Energy}(\mathbf{x}, \mathbf{h})}}{Z} = \frac{e^{-\text{FreeEnergy}(\mathbf{x})}}{Z}$$

- Can be computed exactly and efficiently in RBMs

$$\text{FreeEnergy}(\mathbf{x}) = -\mathbf{b}'\mathbf{x} - \sum_i \log \sum_{\mathbf{h}_i} e^{\mathbf{h}_i(\mathbf{c}_i + W_i\mathbf{x})}$$

- Marginal likelihood $P(\mathbf{x})$ tractable up to partition function Z

Energy-Based Models Gradient

$$P(\mathbf{x}) = \frac{e^{-\text{Energy}(\mathbf{x})}}{Z} \quad Z = \sum_{\mathbf{x}} e^{-\text{Energy}(\mathbf{x})}$$

$$\frac{\partial \log P(\mathbf{x})}{\partial \theta} = - \frac{\partial \text{Energy}(\mathbf{x})}{\partial \theta} - \frac{\partial \log Z}{\partial \theta}$$

$$\begin{aligned} \frac{\partial \log Z}{\partial \theta} &= \frac{\partial \log \sum_{\mathbf{x}} e^{-\text{Energy}(\mathbf{x})}}{\partial \theta} \\ &= \frac{1}{Z} \frac{\partial \sum_{\mathbf{x}} e^{-\text{Energy}(\mathbf{x})}}{\partial \theta} \\ &= - \frac{1}{Z} \sum_{\mathbf{x}} e^{-\text{Energy}(\mathbf{x})} \frac{\partial \text{Energy}(\mathbf{x})}{\partial \theta} \\ &= - \sum_{\mathbf{x}} P(\mathbf{x}) \frac{\partial \text{Energy}(\mathbf{x})}{\partial \theta} \end{aligned}$$

Boltzmann Machine Gradient

$$P(x) = \frac{1}{Z} \sum_h e^{-\text{Energy}(x,h)} = \frac{1}{Z} e^{-\text{FreeEnergy}(x)}$$

- Gradient has two components:

$$\begin{aligned} \frac{\partial \log P(x)}{\partial \theta} &= \underbrace{-\frac{\partial \text{FreeEnergy}(x)}{\partial \theta}}_{\text{“positive phase”}} + \underbrace{\sum_{\tilde{x}} P(\tilde{x}) \frac{\partial \text{FreeEnergy}(\tilde{x})}{\partial \theta}}_{\text{“negative phase”}} \\ &= \underbrace{-\sum_h P(h|x) \frac{\partial \text{Energy}(x,h)}{\partial \theta}}_{\text{“positive phase”}} + \underbrace{\sum_{\tilde{x}, \tilde{h}} P(\tilde{x}, \tilde{h}) \frac{\partial \text{Energy}(\tilde{x}, \tilde{h})}{\partial \theta}}_{\text{“negative phase”}} \end{aligned}$$

- In RBMs, easy to sample or sum over $h|x$
- Difficult part: sampling from $P(x)$, typically with a Markov chain

Positive & Negative Samples

- Observed (+) examples push the energy down
- Generated / dream / fantasy (-) samples / particles push the energy up

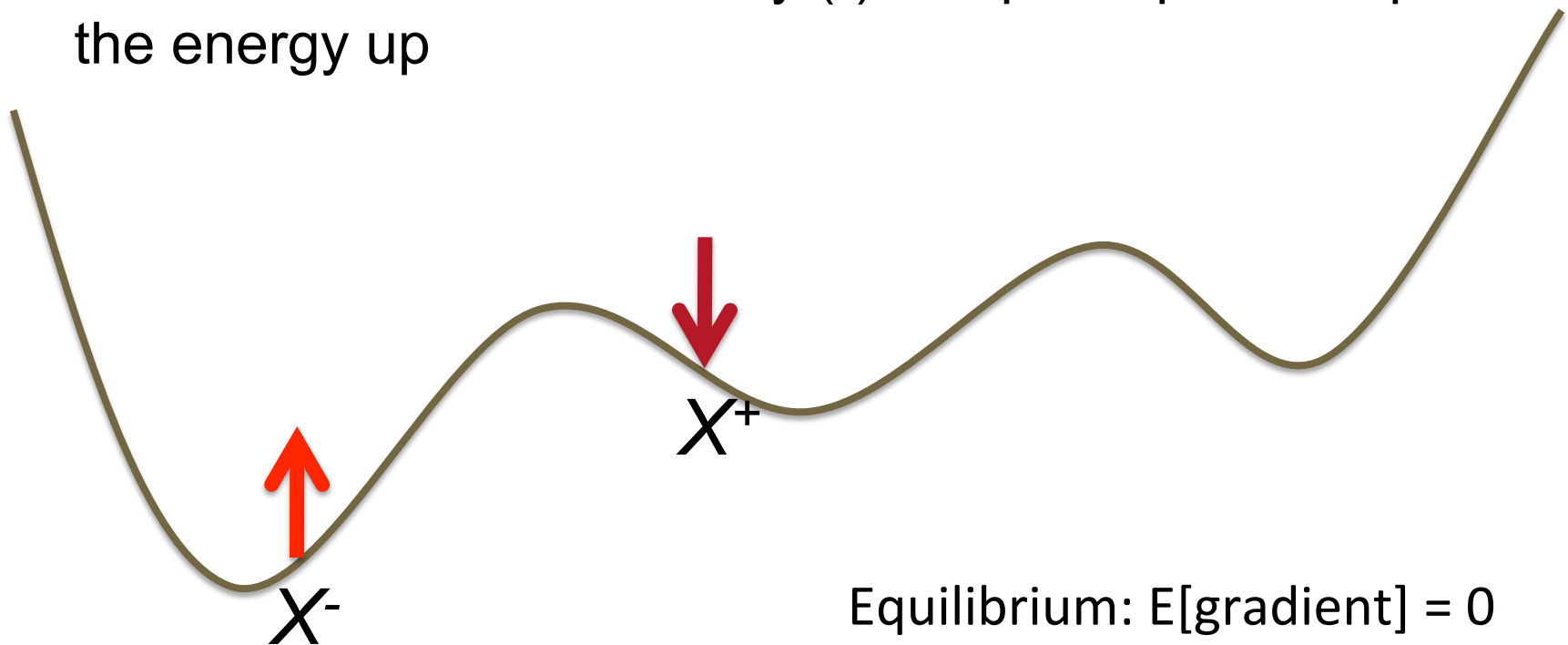

Training RBMs

Contrastive Divergence: start negative Gibbs chain at observed x , run k (CD- k) Gibbs steps

SML/Persistent CD: run negative Gibbs chain in background while (PCD) weights slowly change

Fast PCD: two sets of weights, one with a large learning rate only used for negative phase, quickly exploring modes

Herding: Deterministic near-chaos dynamical system defines both learning and sampling

Tempered MCMC: use higher temperature to escape modes

Contrastive Divergence



Contrastive Divergence (CD-k): start negative phase
block Gibbs chain at observed x , run k Gibbs steps

(Hinton 2002)

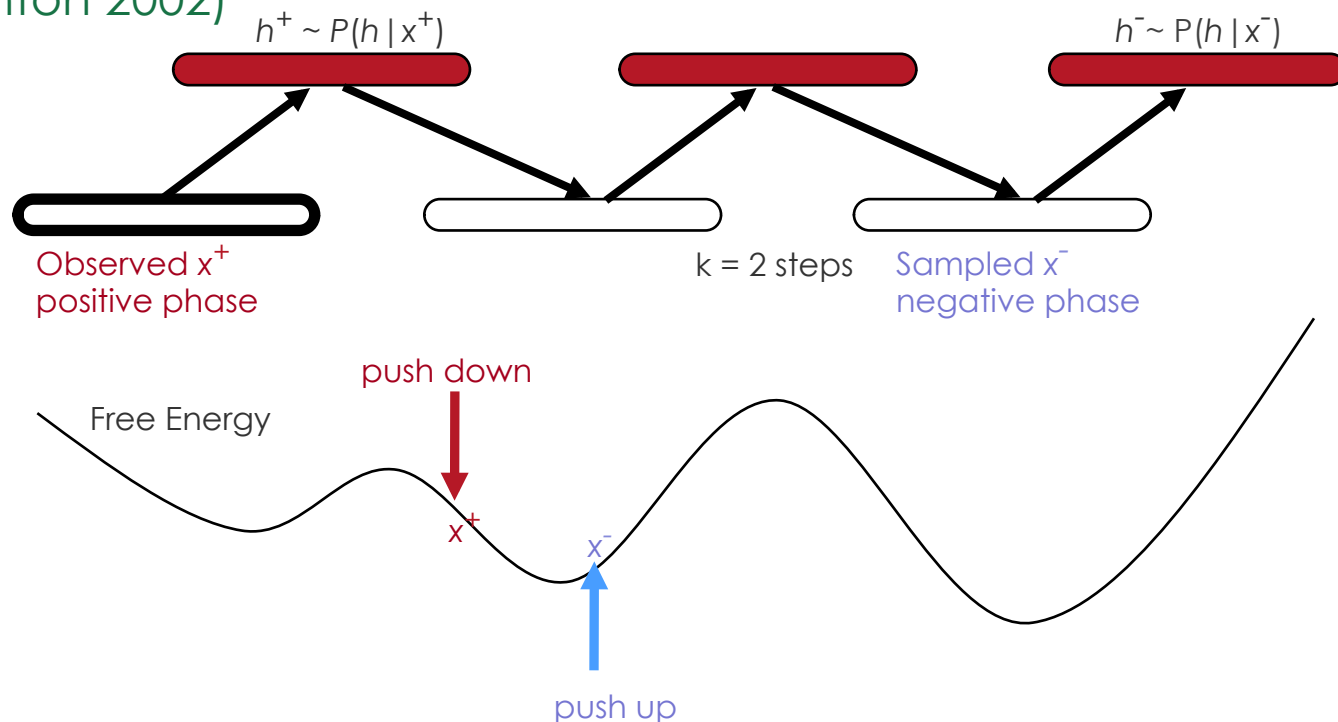

Persistent CD (PCD) / Stochastic Max. Likelihood (SML)

Run negative Gibbs chain in background while weights slowly change (Younes 1999, Tieleman 2008):

- Guarantees (Younes 1999; Yuille 2005)
- If learning rate decreases in $1/t$, chain mixes before parameters change too much, chain stays converged when parameters change

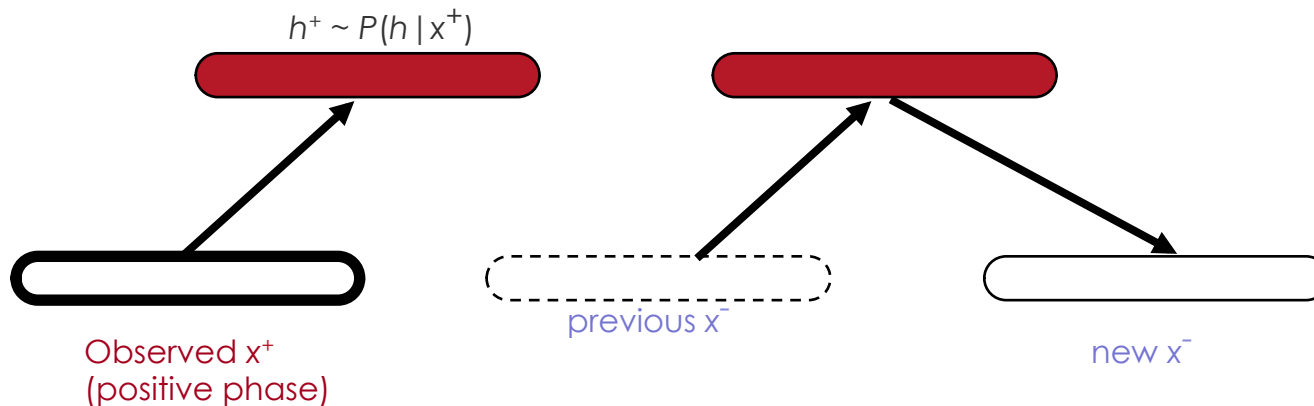

Some RBM Variants

- Different energy functions and allowed values for the hidden and visible units:
 - Hinton et al 2006: binary-binary RBMs
 - Welling NIPS'2004: exponential family units
 - Ranzato & Hinton CVPR'2010: Gaussian RBM weaknesses (no conditional covariance), propose mcRBM
 - Ranzato et al NIPS'2010: mPoT, similar energy function
 - Courville et al ICML'2011: spike-and-slab RBM



Convolutionally Trained Spike & Slab RBMs Samples

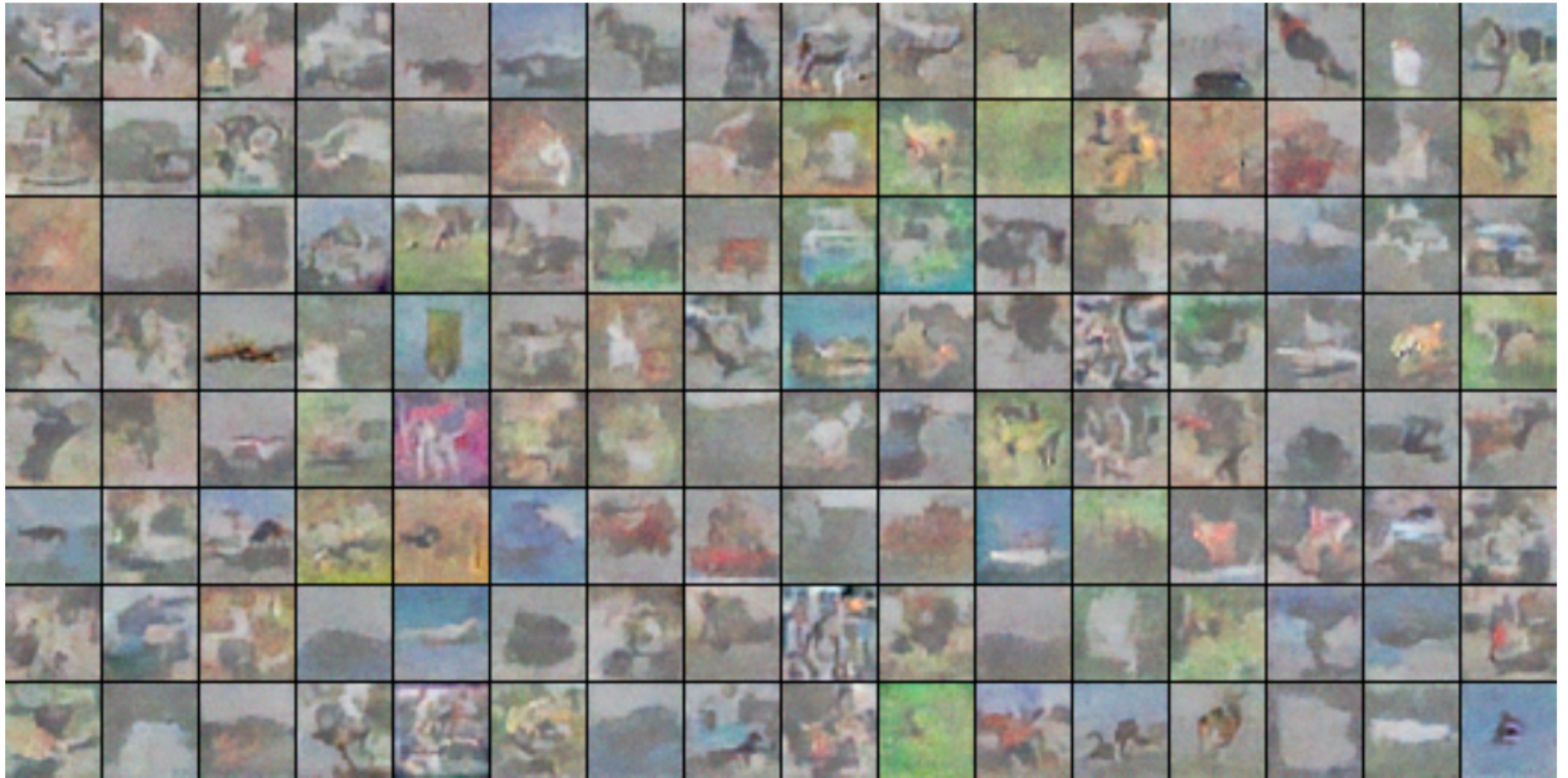

ssRBM is not Cheating

Samples from μ -ssRBM:



Nearest examples in CIFAR:
(least square dist.)

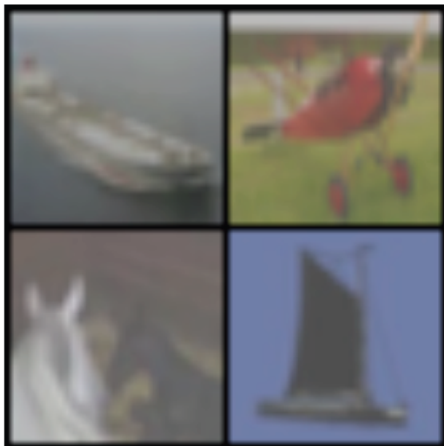

Generated samples

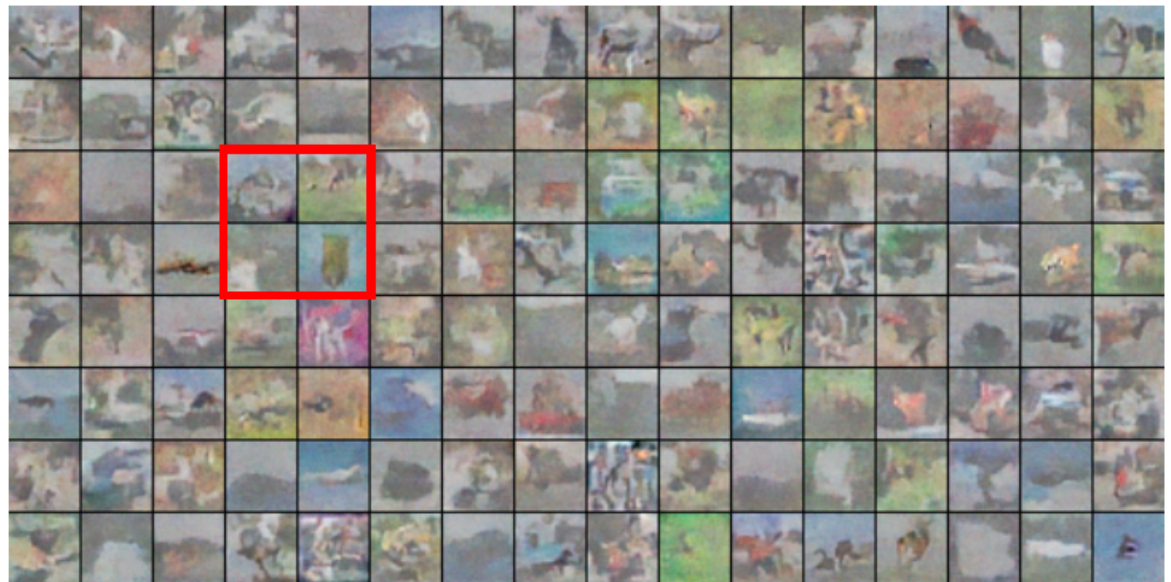

Training examples

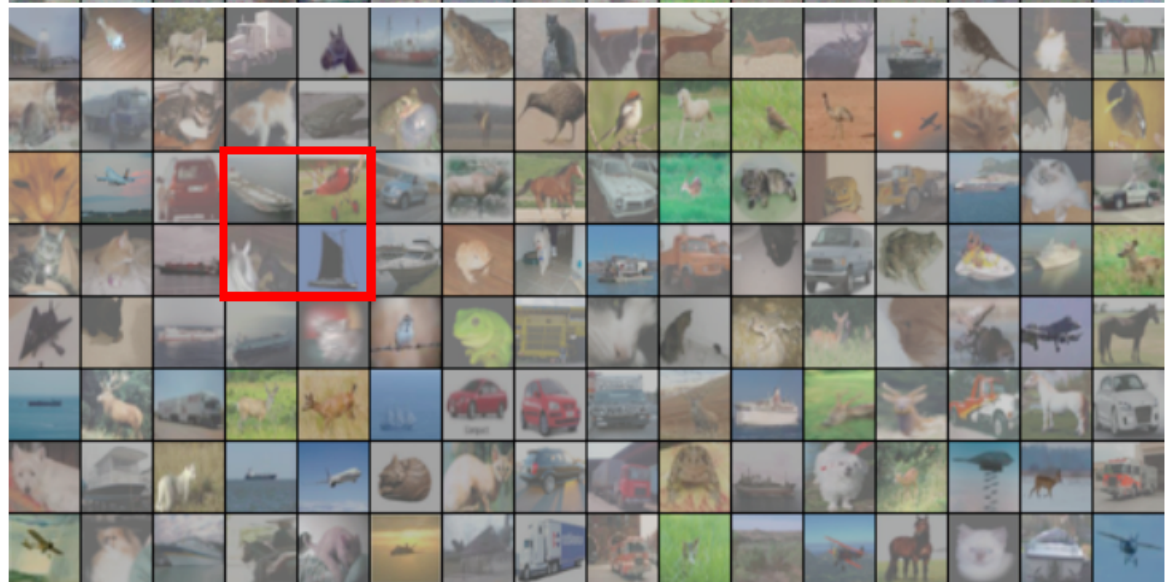

Time for a break

Auto-Encoders & Variants: Learning a computational graph

Computational Graphs

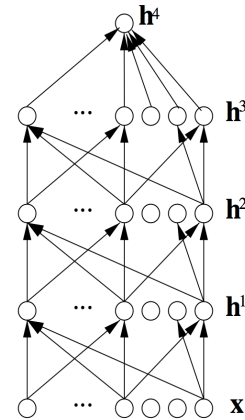

- Operations for particular task
- Neural nets' structure = computational graph for $P(y|\mathbf{x})$
- Graphical model's structure \neq computational graph for inference
- Recurrent nets & graphical models

➔ family of computational graphs sharing parameters

- *Could we have a parametrized family of computational graphs defining "the model"?*

Simple Auto-Encoders

- MLP whose target output = input
- Reconstruction=decoder(encoder(input)),
e.g.

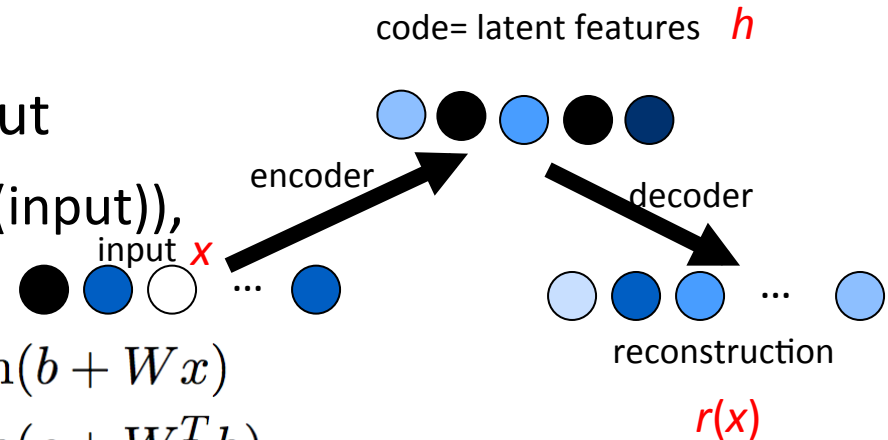

$$h = \tanh(b + Wx)$$

$$\text{reconstruction} = \tanh(c + W^T h)$$

$$\text{Loss } L(x, \text{reconstruction}) = \|\text{reconstruction} - x\|^2$$

- With bottleneck, code = new coordinate system
- Encoder and decoder can have 1 or more layers
- Training deep auto-encoders notoriously difficult

Link Between Contrastive Divergence and Auto-Encoder Reconstruction Error Gradient

- (Bengio & Delalleau 2009):

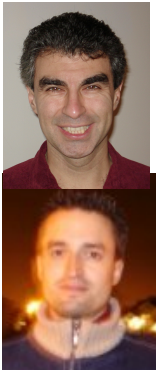

- CD-2k estimates the log-likelihood gradient from 2k diminishing terms of an expansion that mimics the Gibbs steps
- reconstruction error gradient looks only at the first step, i.e., is a kind of mean-field approximation of CD-0.5

$$\frac{\partial \log P(x_1)}{\partial \theta} = \sum_{s=1}^{t-1} \left(E \left[\frac{\partial \log P(x_s | h_s)}{\partial \theta} \middle| x_1 \right] + E \left[\frac{\partial \log P(h_s | x_{s+1})}{\partial \theta} \middle| x_1 \right] \right) + E \left[\frac{\partial \log P(x_t)}{\partial \theta} \middle| x_1 \right]$$

I finally understand what auto-encoders do!

- Try to carve holes in $\|r(x)-x\|^2$ or $-\log P(x | h(x))$ at examples



- Vector $r(x)-x$ points in direction of increasing prob., i.e. estimate score = $d \log p(x) / dx$: learn **score** vector field = **local mean**
- Generalize (*valleys*) in between above holes to form *manifolds*
 - $dr(x)/dx$ estimates the **local covariance** and is linked to the Hessian $d^2 \log p(x) / dx^2$
- **A Markov Chain associated with AEs estimates the data-generating distribution (Bengio et al, arxiv 1305.663, 2013)**

Stacking Auto-Encoders

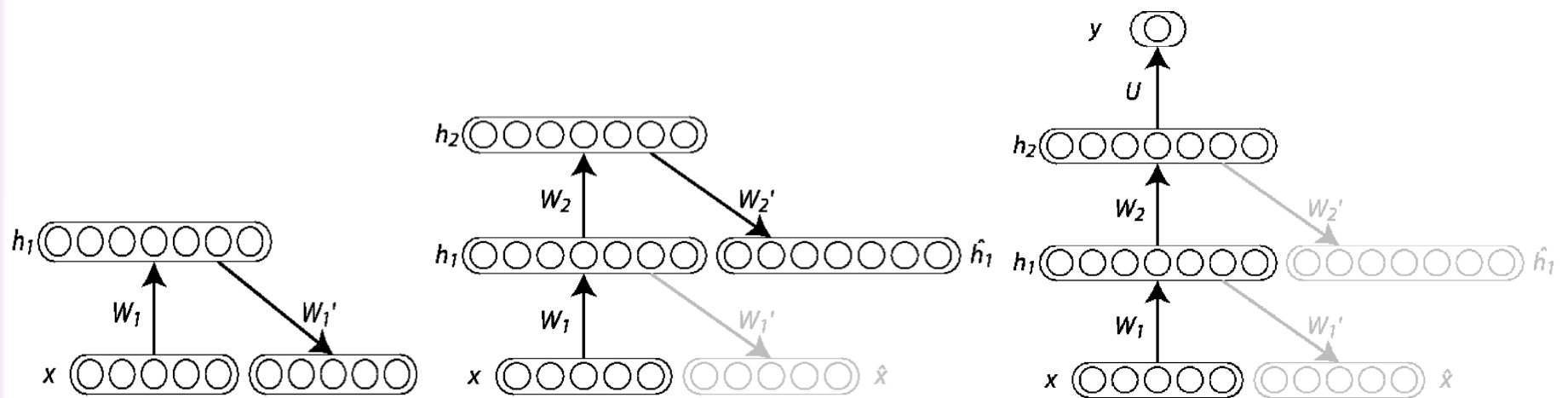

Auto-encoders can be stacked successfully (Bengio et al NIPS'2006) to form highly non-linear representations, which with fine-tuning overperformed purely supervised MLPs

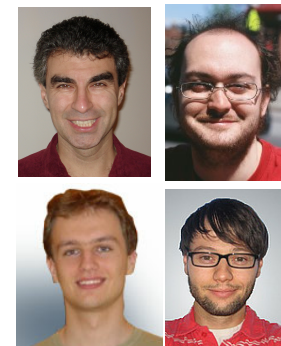

Greedy Layerwise Supervised Training

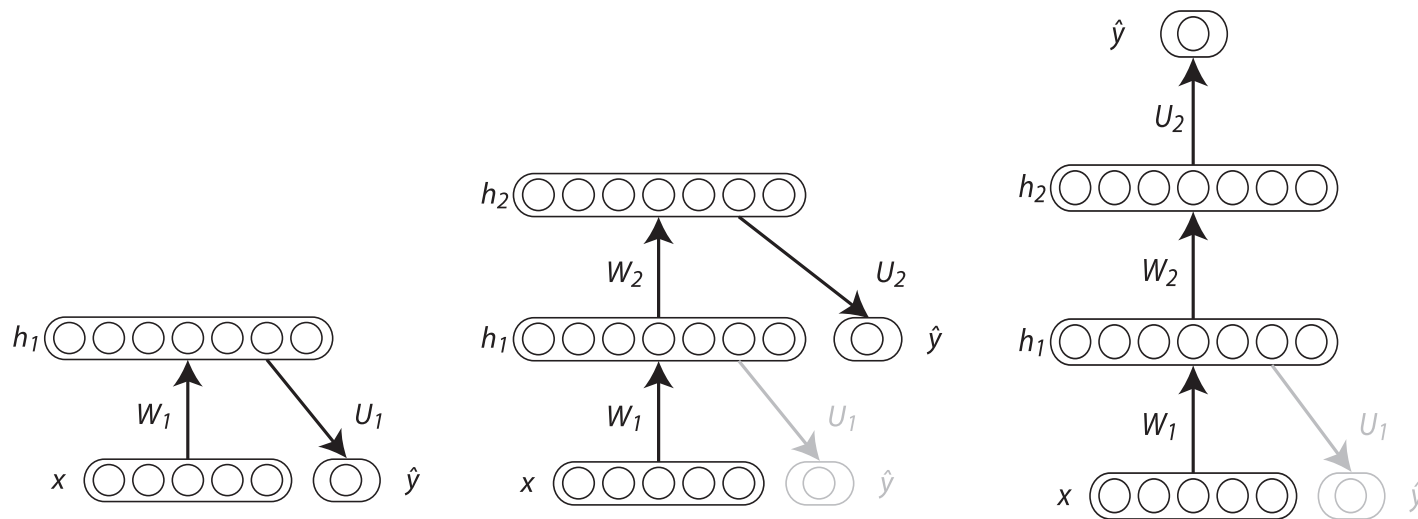

Generally worse than unsupervised pre-training but better than ordinary training of a deep neural network (Bengio et al. NIPS'2006). Has been used successfully on large labeled datasets, where unsupervised pre-training did not make as much of an impact.

Supervised Fine-Tuning is Important

- Greedy layer-wise unsupervised pre-training phase with RBMs or auto-encoders on MNIST
- Supervised phase with or without unsupervised updates, with or without fine-tuning of hidden layers
- Can train all RBMs at the same time, same results

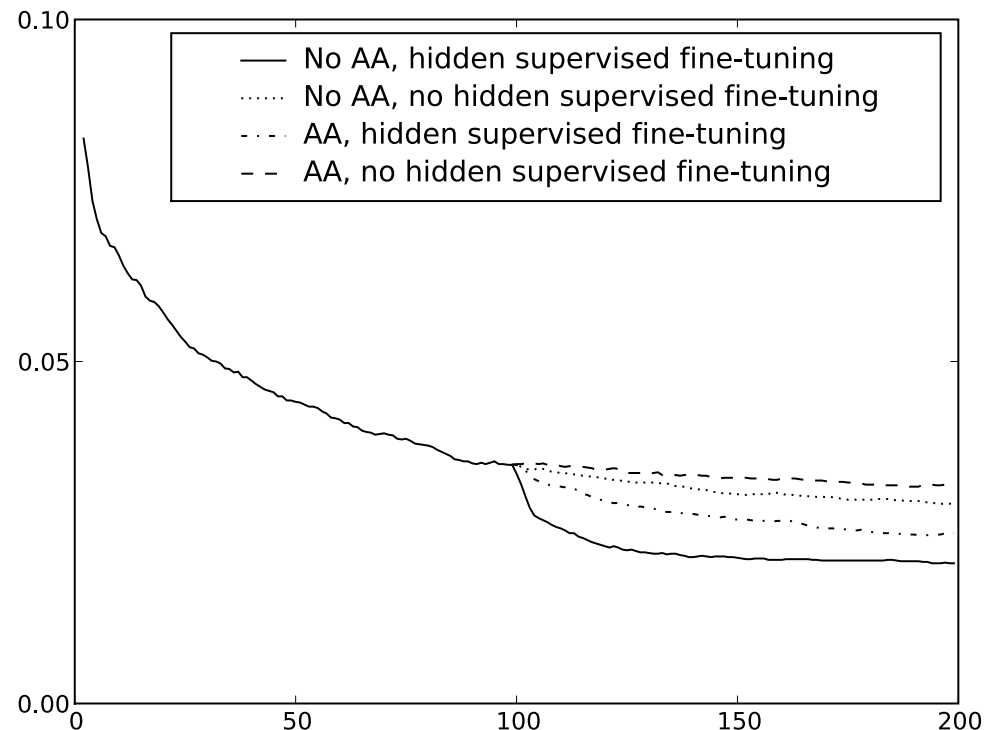

(Auto-Encoder) Reconstruction Loss

- Discrete inputs: cross-entropy for binary inputs
 - $-\sum_i x_i \log r_i(x) + (1-x_i) \log(1-r_i(x))$ (with $0 < r_i(x) < 1$)or log-likelihood reconstruction criterion, e.g., for a multinomial (one-hot) input
 - $-\sum_i x_i \log r_i(x)$ (where $\sum_i r_i(x) = 1$, summing over subset of inputs associated with this multinomial variable)
- In general: consider what are appropriate loss functions to predict each of the input variables,
typically, **reconstruction neg. log-likelihood $-\log P(x|h(x))$**

Manifold Learning

- Additional prior: examples **concentrate** near a lower dimensional “manifold” (region of high density with only few operations allowed which allow small changes while staying on the manifold)

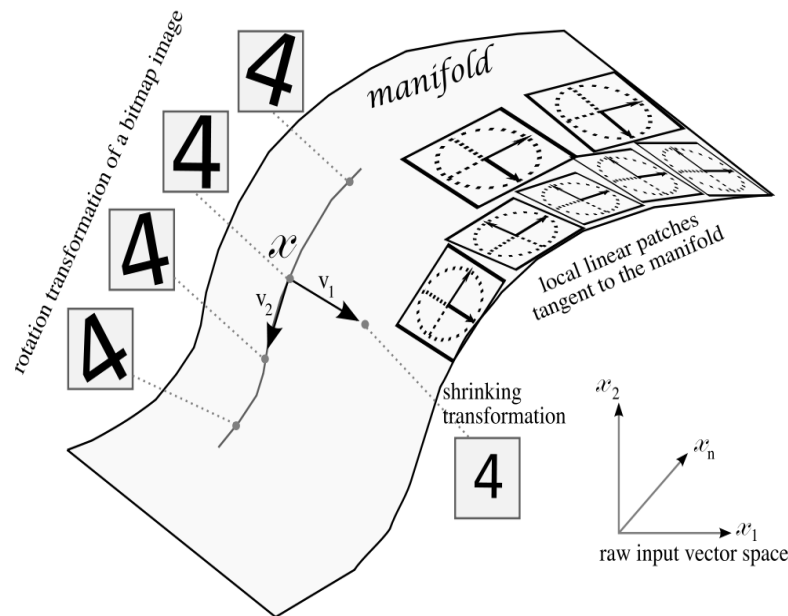

- variable dimension locally?
- Soft # of dimensions?

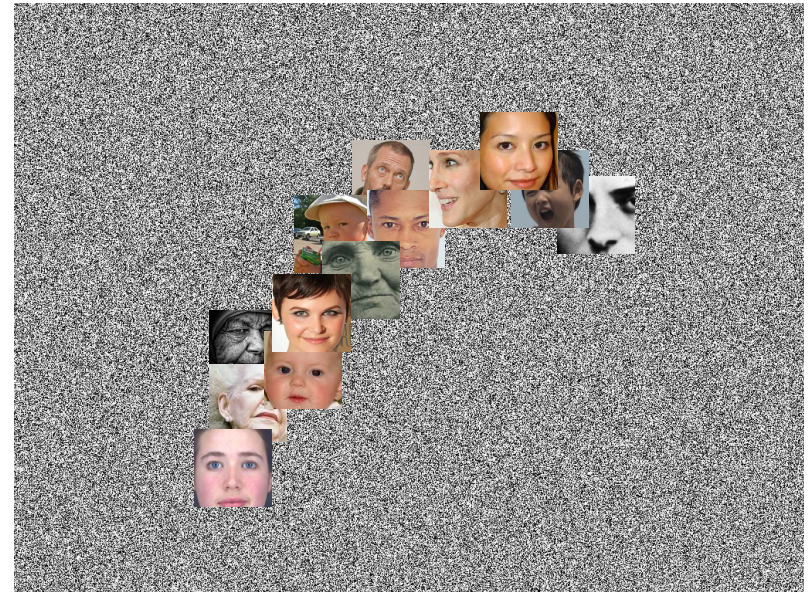

Denoising Auto-Encoder

(Vincent et al 2008)



- Corrupt the input during training only
- Train to reconstruct the uncorrupted input

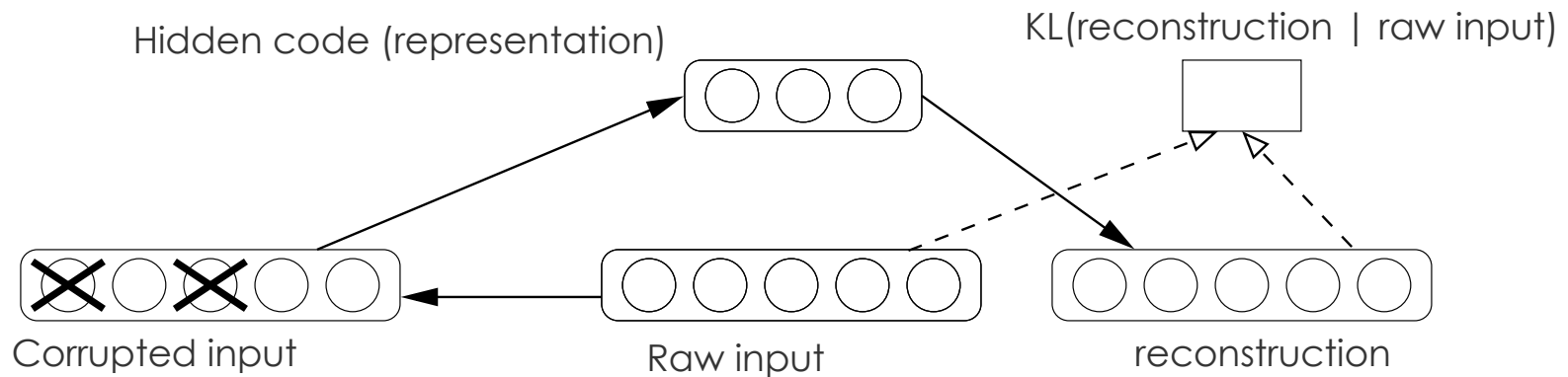

- Encoder & decoder: any parametrization
- As good or better than RBMs for unsupervised pre-training

Denoising Auto-Encoder

- Learns a vector field pointing towards higher probability direction (Alain & Bengio 2013)



$$r(x)-x \propto d\log p(x)/dx$$

- Some DAEs correspond to a kind of Gaussian RBM with *regularized* Score Matching (Vincent 2011)



[equivalent when noise $\rightarrow 0$]

- Compared to RBM:
No partition function issue,
+ can measure training
criterion

prior: examples concentrate near a lower dimensional "manifold"

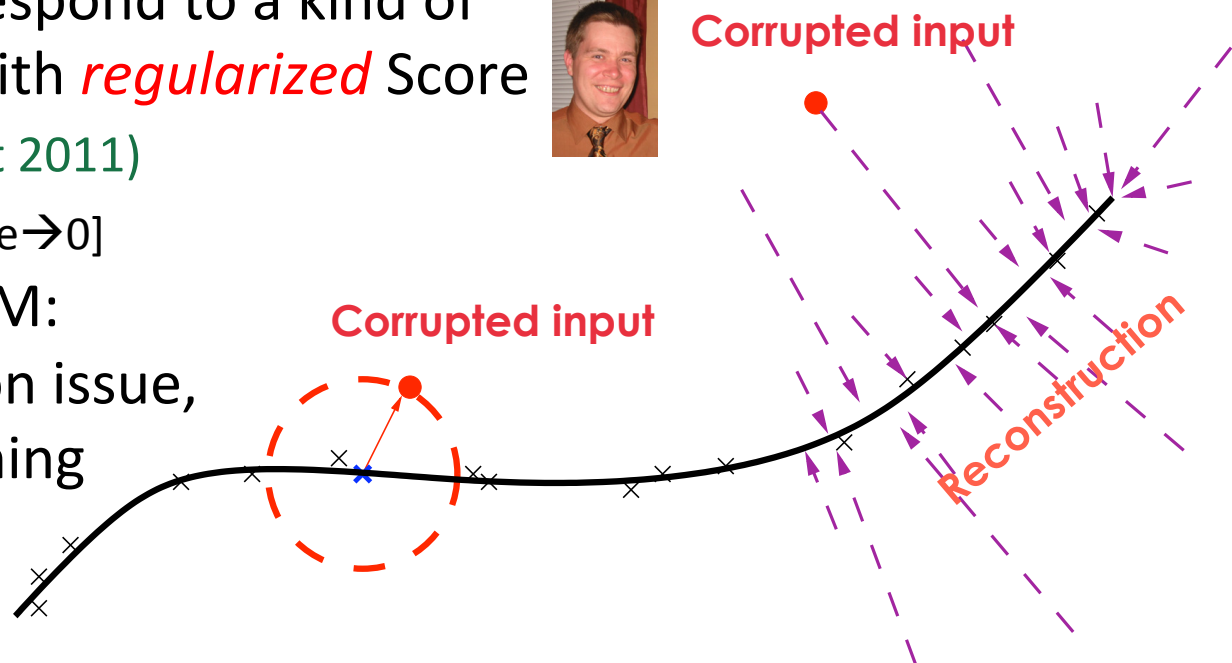

Stacked Denoising Auto-Encoders

Budget of 10 million iterations

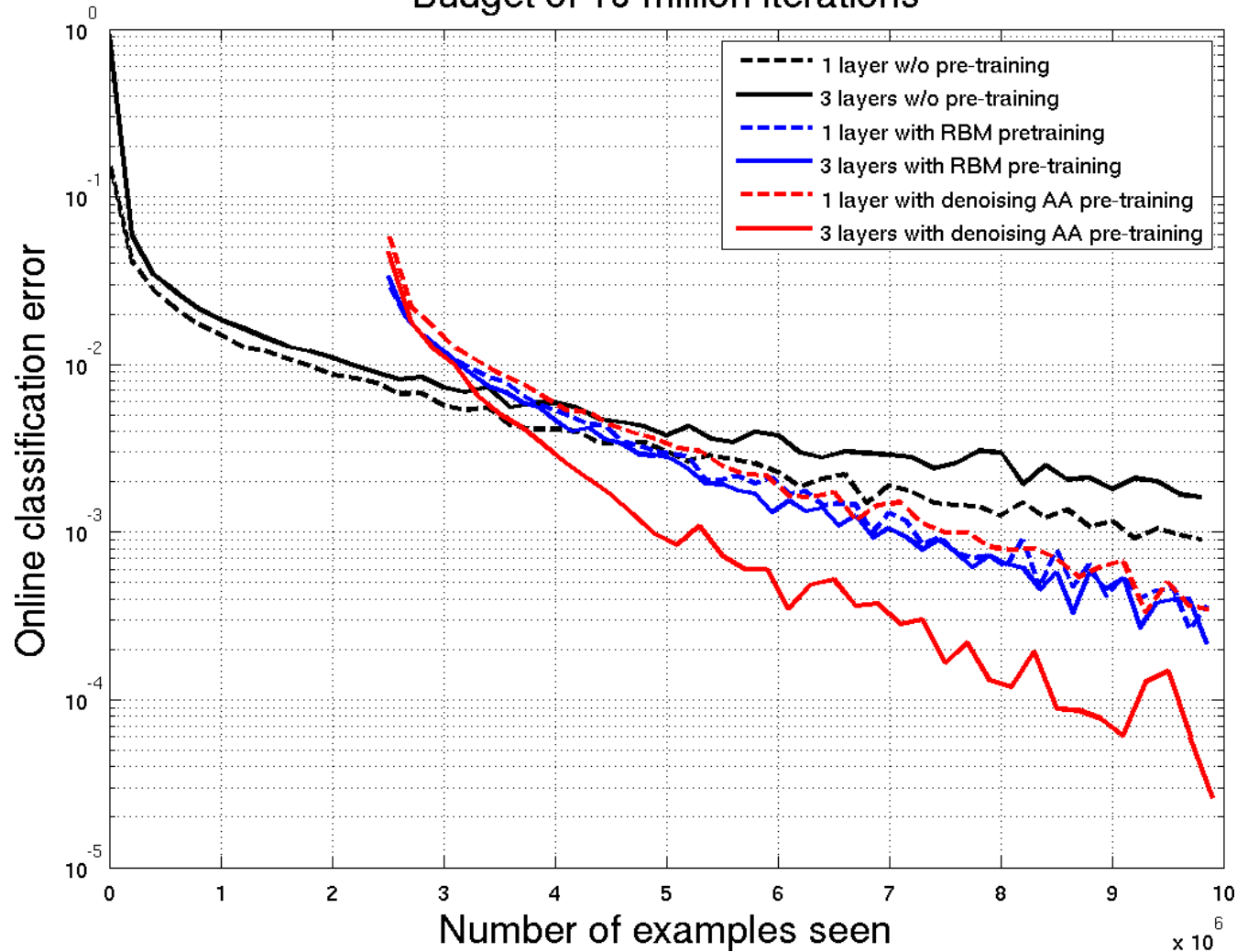

Infinite MNIST

Note how advantage of better initialization does not vanish like other regularizers as #examples $\rightarrow \infty$

Auto-Encoders Learn Salient Variations, Like a non-linear PCA

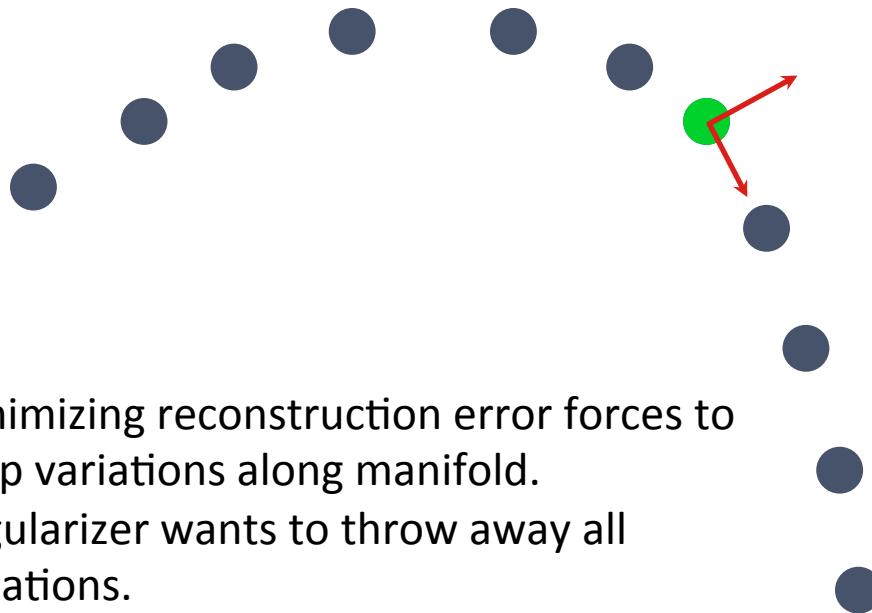

- Minimizing reconstruction error forces to keep variations along manifold.
- Regularizer wants to throw away all variations.
- With both: keep ONLY sensitivity to variations ON the manifold.

Regularized Auto-Encoders Learn a Vector Field or a Markov Chain Transition Distribution

- (Bengio, Vincent & Courville, TPAMI 2013) review paper
- (Alain & Bengio ICLR 2013; Bengio et al, arxiv 2013)

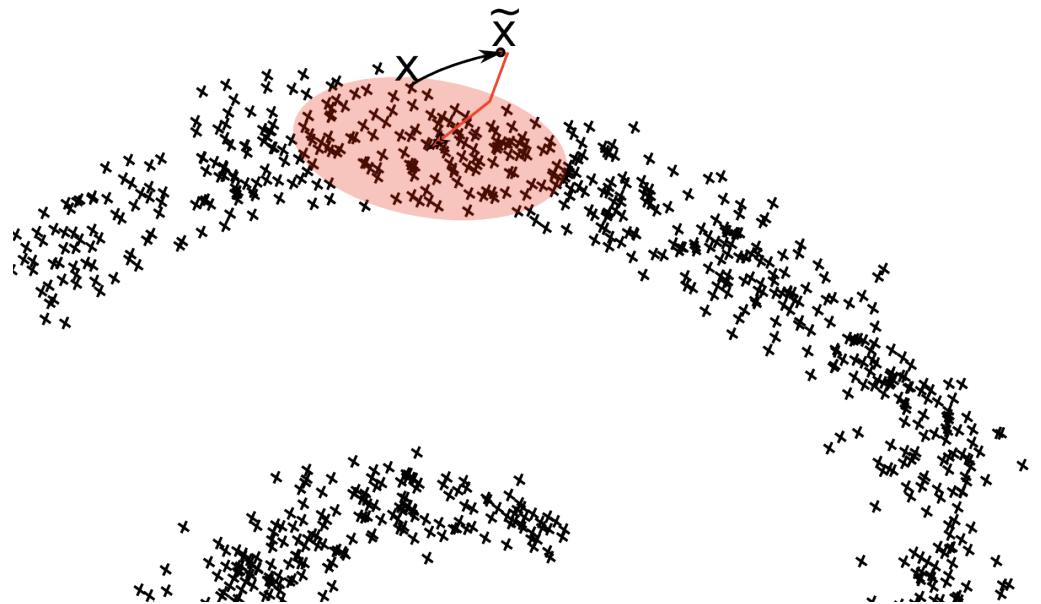
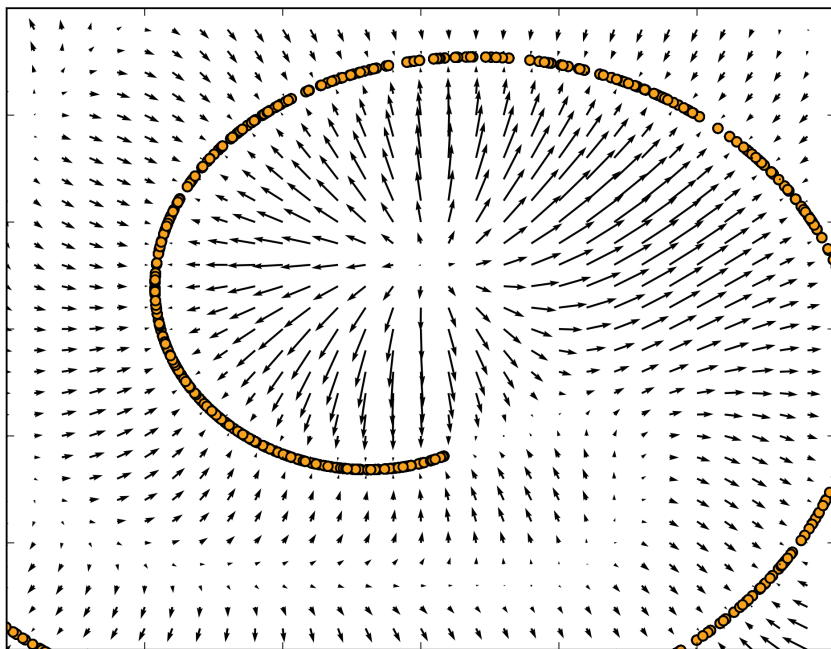

Contractive Auto-Encoders

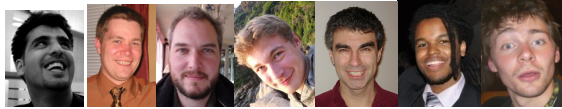

(Rifai, Vincent, Muller, Glorot, Bengio ICML 2011; Rifai, Mesnil, Vincent, Bengio, Dauphin, Glorot ECML 2011; Rifai, Dauphin, Vincent, Bengio, Muller NIPS 2011)

$$\text{reconstruction}(x) = g(h(x)) = \text{decoder}(\text{encoder}(x))$$

Training criterion:

$$\mathcal{J}_{CAE}(\theta) = \sum_{x \in D_n} \lambda \sum_{ij} \left(\frac{\partial h_j(x)}{\partial x_i} \right)^2 + L(x, \text{reconstruction}(x))$$

wants contraction in all directions

cannot afford contraction in manifold directions

If $h_j = \text{sigmoid}(b_j + W_j x)$

$$(dh_j(x)/dx_i)^2 = h_j^2(1-h_j)^2 W_{ji}^2$$

Contractive Auto-Encoders

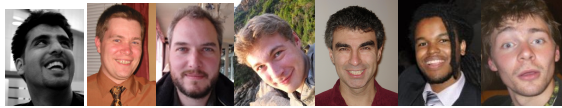

(Rifai, Vincent, Muller, Glorot, Bengio ICML 2011; Rifai, Mesnil, Vincent, Bengio, Dauphin, Glorot ECML 2011; Rifai, Dauphin, Vincent, Bengio, Muller NIPS 2011)

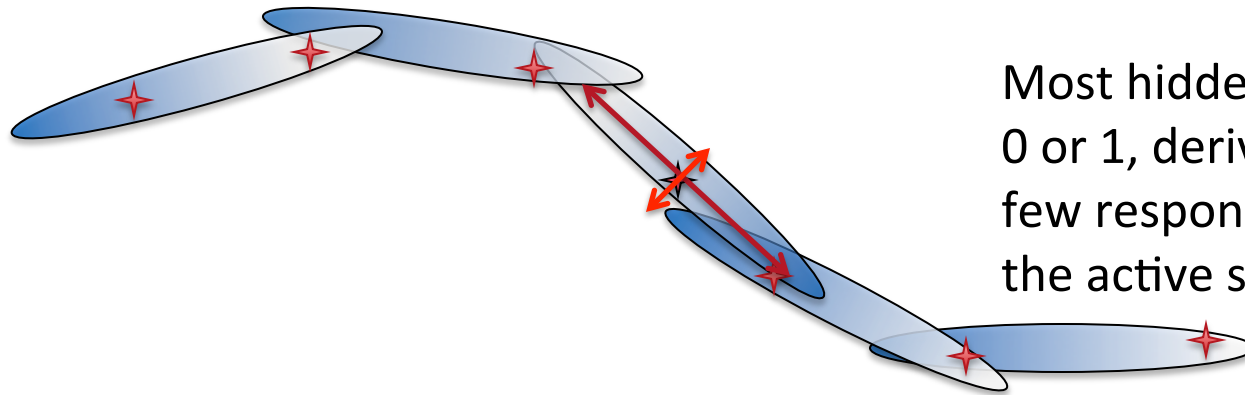

Most hidden units **saturate** (near 0 or 1, derivative near 0):
few responsive units represent
the active subspace (local chart)

Each region/chart = subset of active hidden units

Neighboring region: one of the units becomes active/inactive

SHARED SET OF FILTERS ACROSS REGIONS, EACH USING A SUBSET

CIFAR-10

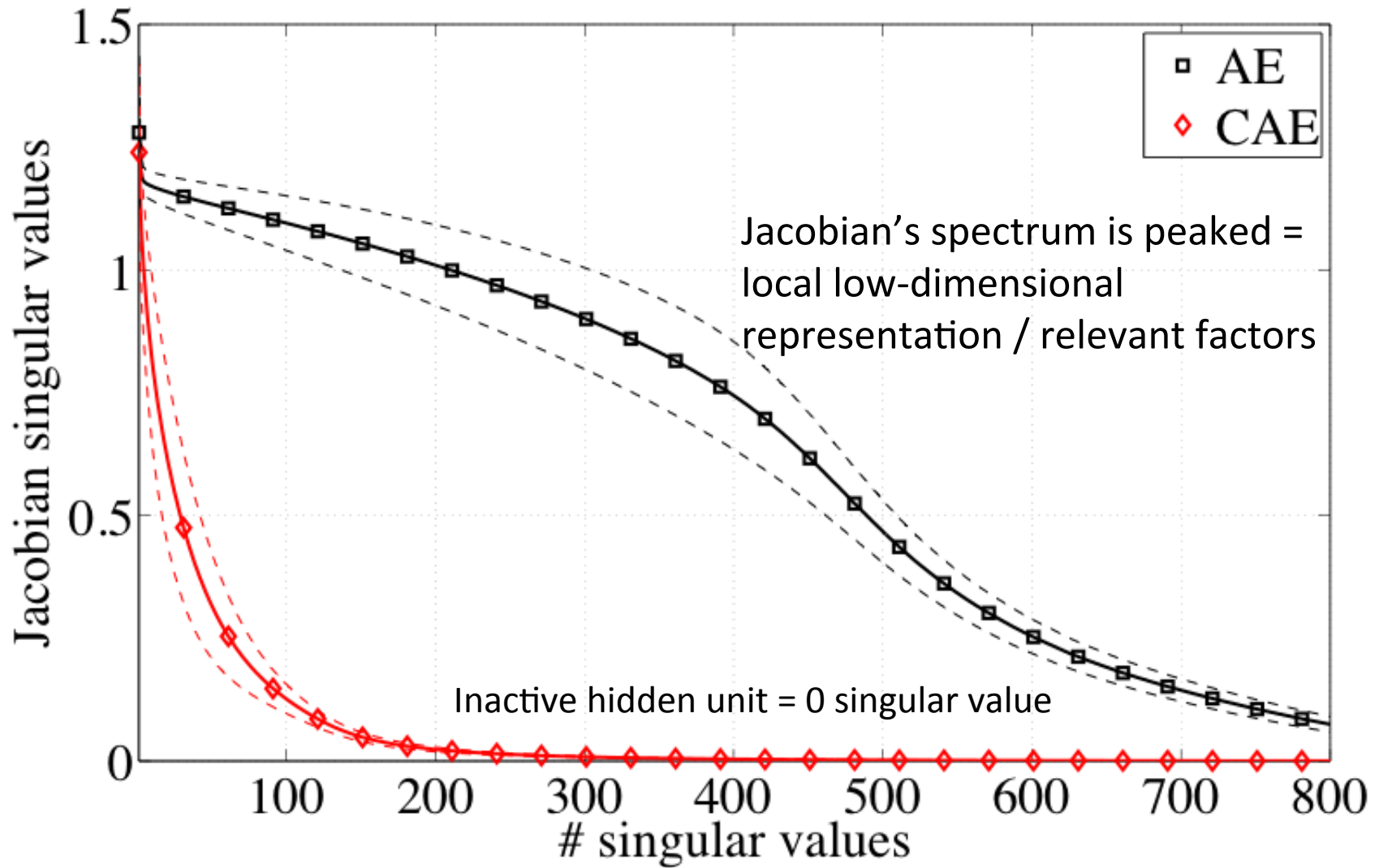

Contractive Auto-Encoders

Benchmark of medium-size datasets on which several deep learning algorithms had been evaluated (Larochelle et al ICML 2007)

Data Set	SVM _{rbf}	SAE-3	RBM-3	DAE-b-3	CAE-1	CAE-2
<i>basic</i>	3.03 ± 0.15	3.46 ± 0.16	3.11 ± 0.15	2.84 ± 0.15	2.83 ± 0.15	2.48 ± 0.14
<i>rot</i>	11.11 ± 0.28	10.30 ± 0.27	10.30 ± 0.27	9.53 ± 0.26	11.59 ± 0.28	9.66 ± 0.26
<i>bg-rand</i>	14.58 ± 0.31	11.28 ± 0.28	6.73 ± 0.22	10.30 ± 0.27	13.57 ± 0.30	10.90 ± 0.27
<i>bg-img</i>	22.61 ± 0.379	23.00 ± 0.37	16.31 ± 0.32	16.68 ± 0.33	16.70 ± 0.33	15.50 ± 0.32
<i>bg-img-rot</i>	55.18 ± 0.44	51.93 ± 0.44	47.39 ± 0.44	43.76 ± 0.43	48.10 ± 0.44	45.23 ± 0.44
<i>rect</i>	2.15 ± 0.13	2.41 ± 0.13	2.60 ± 0.14	1.99 ± 0.12	1.48 ± 0.10	1.21 ± 0.10
<i>rect-img</i>	24.04 ± 0.37	24.05 ± 0.37	22.50 ± 0.37	21.59 ± 0.36	21.86 ± 0.36	21.54 ± 0.36

Input Point



Tangents

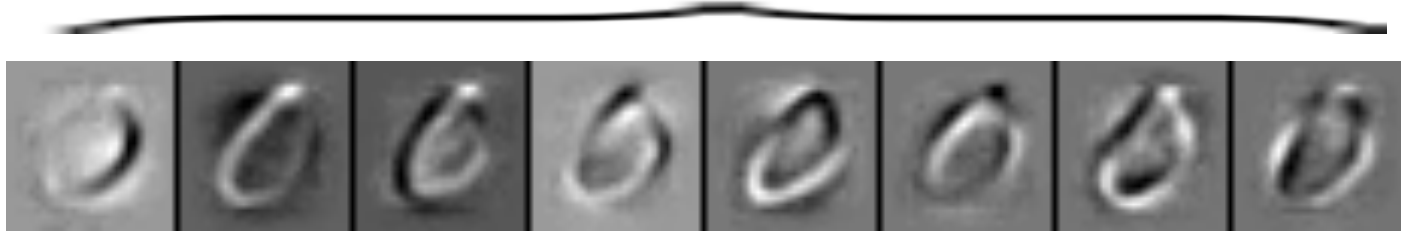

$$\text{Input Point} + 0.5 \times \text{Tangent} = \text{Result}$$

MNIST

Input Point



Tangents

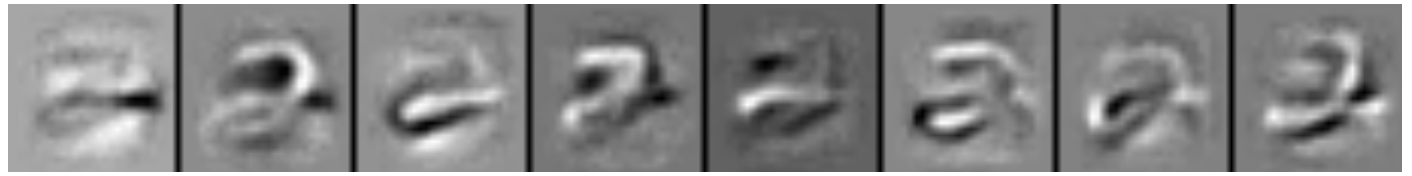

MNIST Tangents

Distributed vs Local (CIFAR-10 unsupervised)

Input Point



Tangents



Local PCA (no sharing across regions)

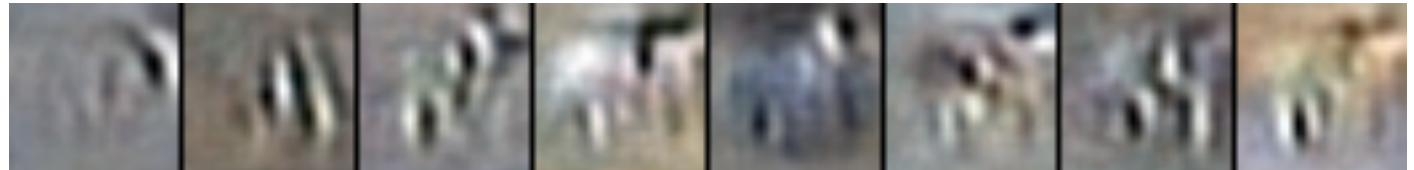

Contractive Auto-Encoder

Denoising auto-encoders are also contractive!

- Taylor-expand Gaussian corruption noise in reconstruction error:

$$\begin{aligned} E[\ell(x, r(x + \epsilon))] &\approx E\left[\left(x - \left(r(x) + \frac{\partial r(x)}{\partial x}\epsilon\right)\right)^T \left(x - \left(r(x) + \frac{\partial r(x)}{\partial x}\epsilon\right)\right)\right] \\ &= E[\|x - r(x)\|^2] + \sigma^2 E\left[\left\|\frac{\partial r(x)}{\partial x}\right\|_F^2\right] \end{aligned}$$

- Yields a contractive penalty in the **reconstruction function** (instead of encoder) proportional to amount of corruption noise

Learned Tangent Prop: the Manifold Tangent Classifier

(Rifai et al NIPS 2011)

3 hypotheses:

1. Semi-supervised hypothesis ($P(x)$ related to $P(y|x)$)
2. Unsupervised manifold hypothesis (data concentrates near low-dim. manifolds)
3. Manifold hypothesis for classification (low density between class manifolds)

Learned Tangent Prop: the Manifold Tangent Classifier

Algorithm:

1. Estimate local principal directions of variation $U(x)$ by CAE (principal singular vectors of $dh(x)/dx$)
2. Penalize $f(x)=P(y|x)$ predictor by $|| df/dx U(x) ||$

Makes $f(x)$ insensitive to variations on manifold at x , tangent plane characterized by $U(x)$.

Manifold Tangent Classifier Results

- Leading singular vectors on MNIST, CIFAR-10, RCV1:

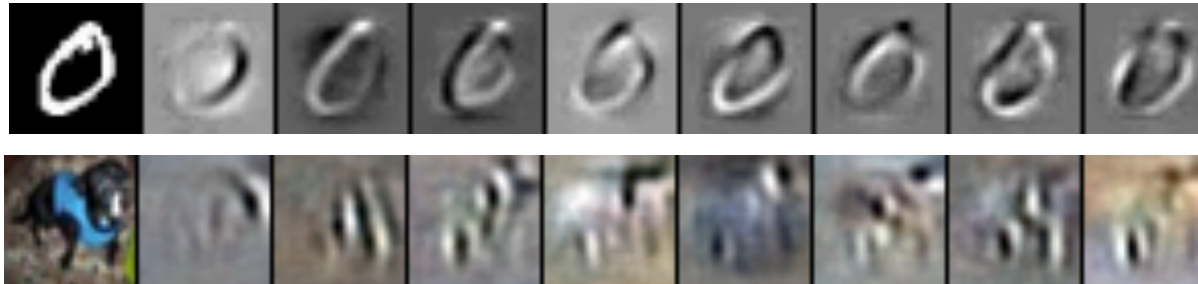

Trading & Markets	+gilt +yen +usda	-slow -term -debt	+matur +auction +treasur	-percent -sent -pressure	+bln +coupon +discount	-anti -predict -belgian	+interest +calcul +overnight	-sen -californ -introduc
-------------------------	------------------------	-------------------------	--------------------------------	--------------------------------	------------------------------	-------------------------------	------------------------------------	--------------------------------

- Knowledge-free MNIST: 0.81% error**

K-NN	NN	SVM	DBN	CAE	DBM	CNN	MTC
3.09%	1.60%	1.40%	1.17%	1.04%	0.95%	0.95%	0.81%

- Semi-sup.

	NN	SVM	CNN	TSVM	DBN-rNCA	EmbedNN	CAE	MTC
100	25.81	23.44	22.98	16.81	-	16.86	13.47	12.03
600	11.44	8.85	7.68	6.16	8.7	5.97	6.3	5.13
1000	10.7	7.77	6.45	5.38	-	5.73	4.77	3.64
3000	6.04	4.21	3.35	3.45	3.3	3.59	3.22	2.57

- Forest (500k examples)

SVM	Distributed SVM	MTC
4.11%	3.46%	3.13%

Inference and Explaining Away

- Easy inference in RBMs and regularized Auto-Encoders
- But no explaining away (competition between causes)
- (Coates et al 2011): even when training filters as RBMs it helps to perform additional explaining away (e.g. plug them into a Sparse Coding inference), to obtain better-classifying features

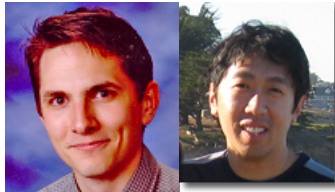

- RBMs would need lateral connections to achieve similar effect
- Auto-Encoders would need to have lateral recurrent connections or deep recurrent structure

Sparse Coding

(Olshausen et al 97)



- Directed graphical model:

$$P(h) \propto e^{-\lambda|h|_1} \quad x|h \sim N(W^T h, \sigma^2 I)$$

- One of the first unsupervised feature learning algorithms with non-linear feature extraction (but linear decoder)

$$\min_h \frac{\|x - W^T h\|^2}{\sigma^2} + \lambda|h|_1$$

MAP inference recovers sparse h although $P(h|x)$ not concentrated at 0

- Linear decoder, non-parametric encoder
- Sparse Coding inference: convex but expensive optimization

Predictive Sparse Decomposition

- Approximate the inference of sparse coding by a parametric encoder:



Predictive Sparse Decomposition

(Kavukcuoglu et al 2008)

- Very successful applications in machine vision with convolutional architectures

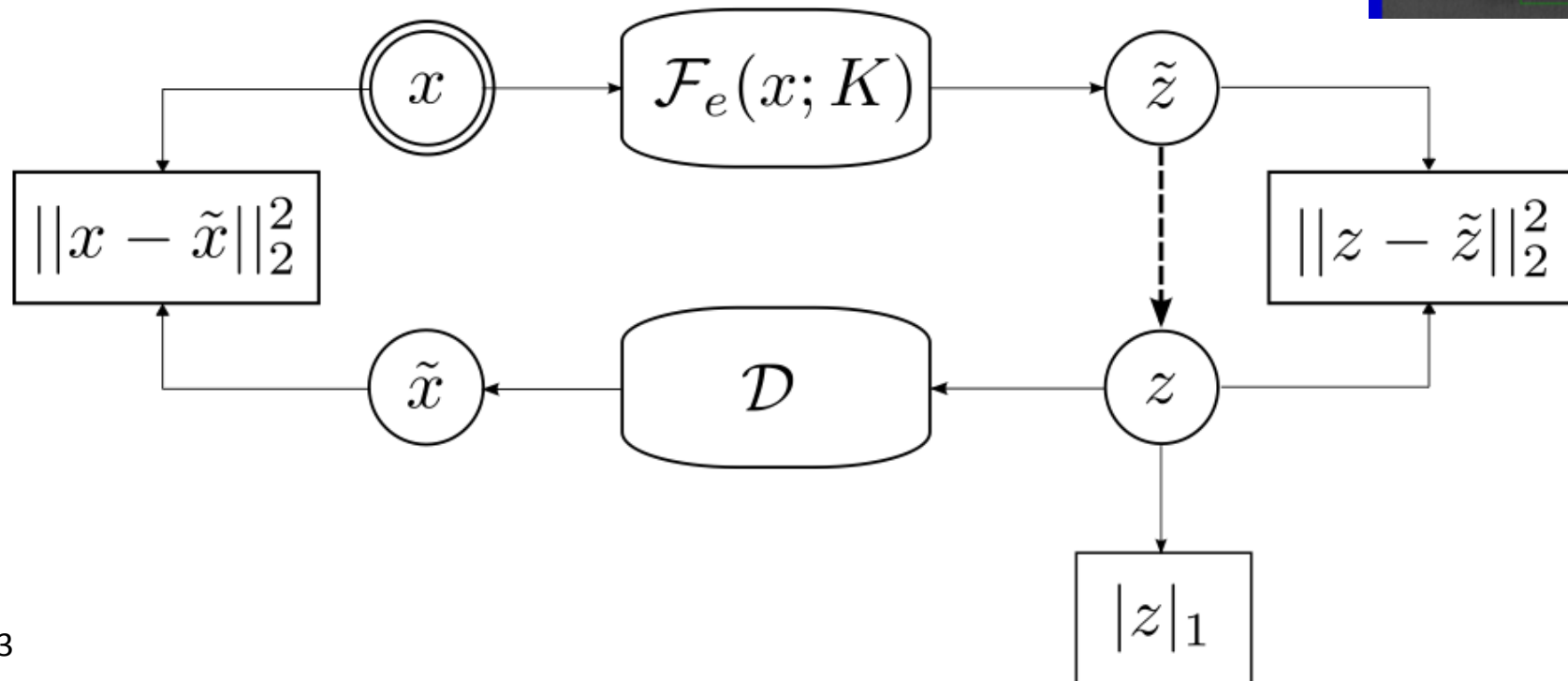
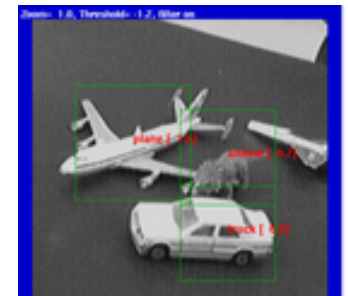

Predictive Sparse Decomposition

- Stacked to form deep architectures
- Alternating convolution, rectification, pooling
- Tiling: no sharing across overlapping filters
- Group sparsity penalty yields topographic maps

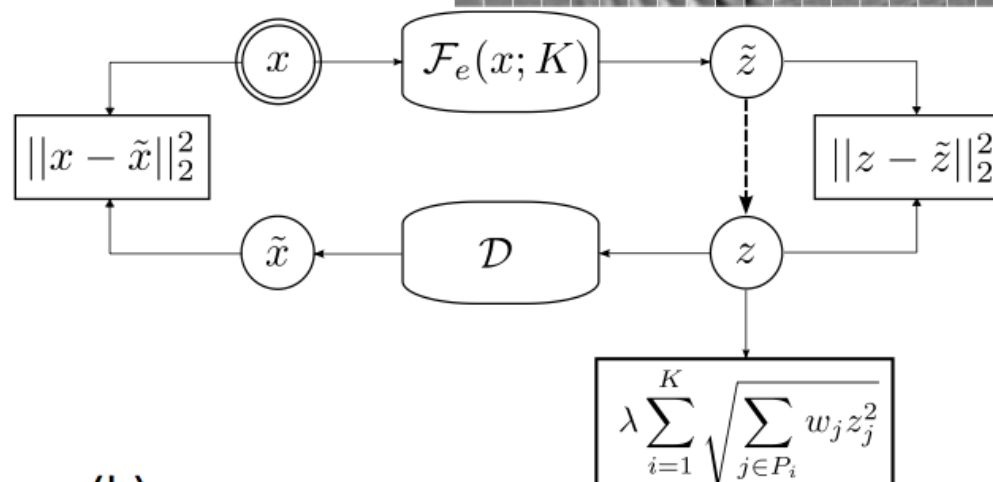
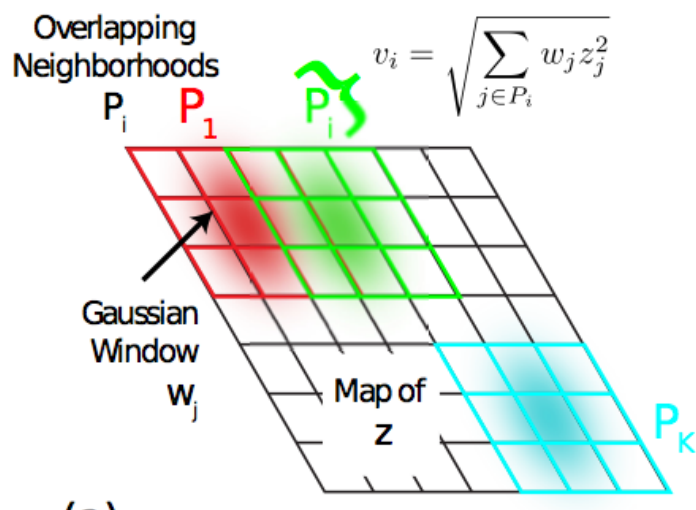
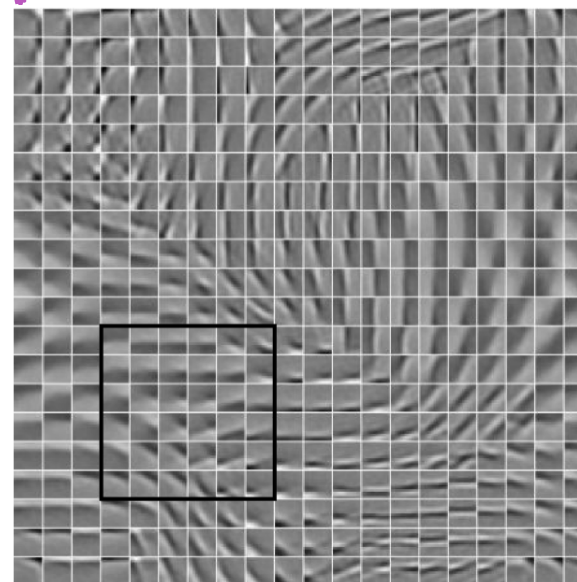

Deep Variants

Level-Local Learning is Important

- Initializing each layer of an unsupervised deep Boltzmann machine helps a lot
- Initializing each layer of a supervised neural network as an RBM, auto-encoder, denoising auto-encoder, etc can help a lot
- Helps most the layers further away from the target
- Not just an effect of the unsupervised prior
- Jointly training all the levels of a deep architecture is difficult because of the increased non-linearity / non-smoothness
- Initializing using a **level-local learning algorithm** is a useful trick
- Providing intermediate-level targets can help tremendously
(Gulcehre & Bengio ICLR 2013)

Stack of RBMs / AEs → Deep MLP

- Encoder or $P(h|v)$ becomes MLP layer

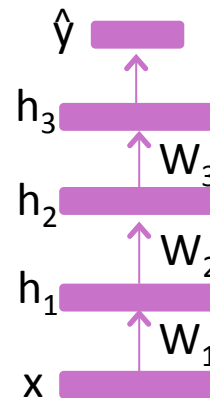
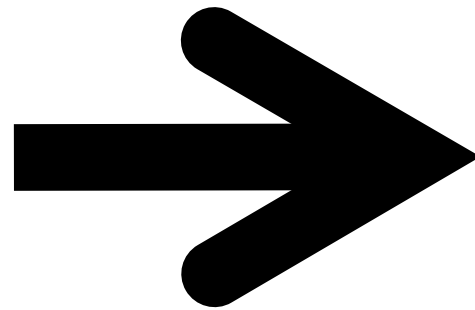
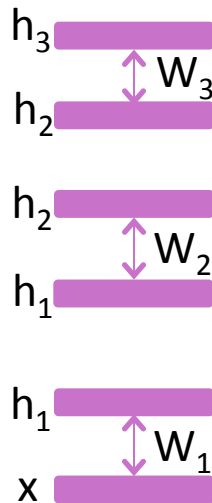

Stack of RBMs / AEs → Deep Auto-Encoder



(Hinton & Salakhutdinov 2006)

- Stack encoders / $P(h|x)$ into deep encoder
- Stack decoders / $P(x|h)$ into deep decoder

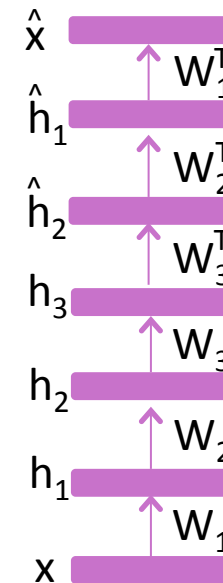
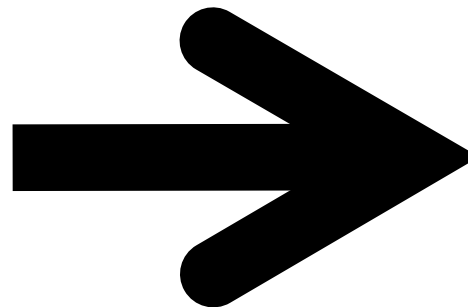
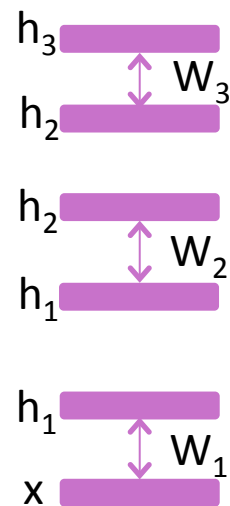

Stack of RBMs / AEs

→ Deep Recurrent Auto-Encoder

(Savard 2011)



(Bengio & Laufer, arxiv 2013)



- Each hidden layer receives input from below and above
- Deterministic (mean-field) recurrent computation (Savard 2011)
- Stochastic (injecting noise) recurrent computation: Deep Generative Stochastic Networks (GSNs)
(Bengio & Laufer arxiv 2013)

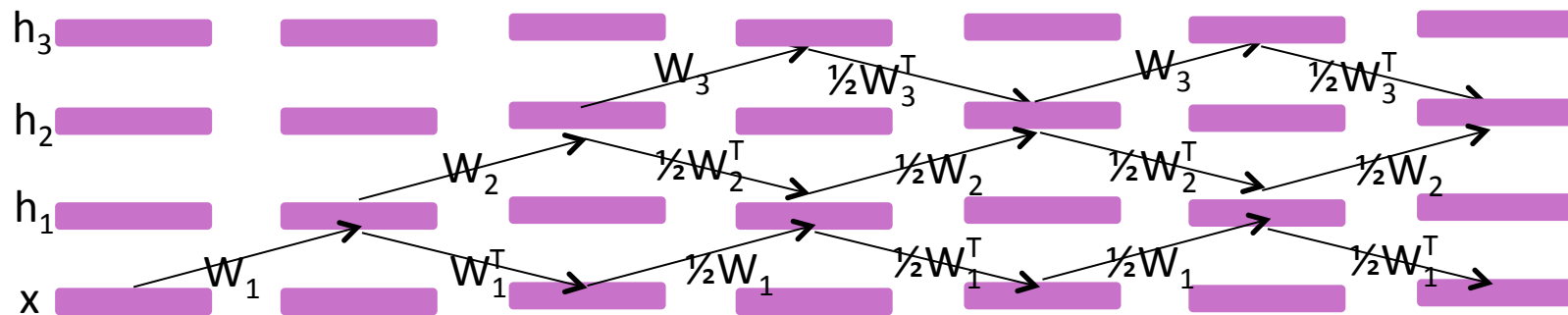
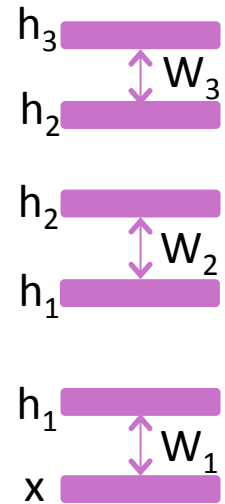

Stack of RBMs → Deep Belief Net



(Hinton et al 2006)

- Stack lower levels RBMs' $P(x|h)$ along with top-level RBM
- $P(x, h_1, h_2, h_3) = P(h_2, h_3) P(h_1|h_2) P(x | h_1)$
- Sample: Gibbs on top RBM, propagate down

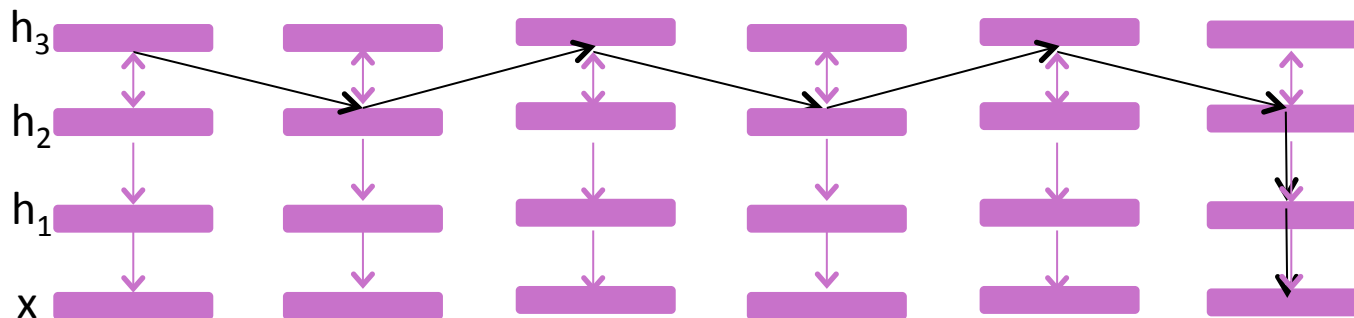



Stack of RBMs

→ Deep Boltzmann Machine

(Salakhutdinov & Hinton AISTATS 2009)

- Halve the RBM weights because each layer now has inputs from below and from above
- Positive phase: (mean-field) variational inference = recurrent AE
- Negative phase: Gibbs sampling (stochastic units)
- train by SML/PCD

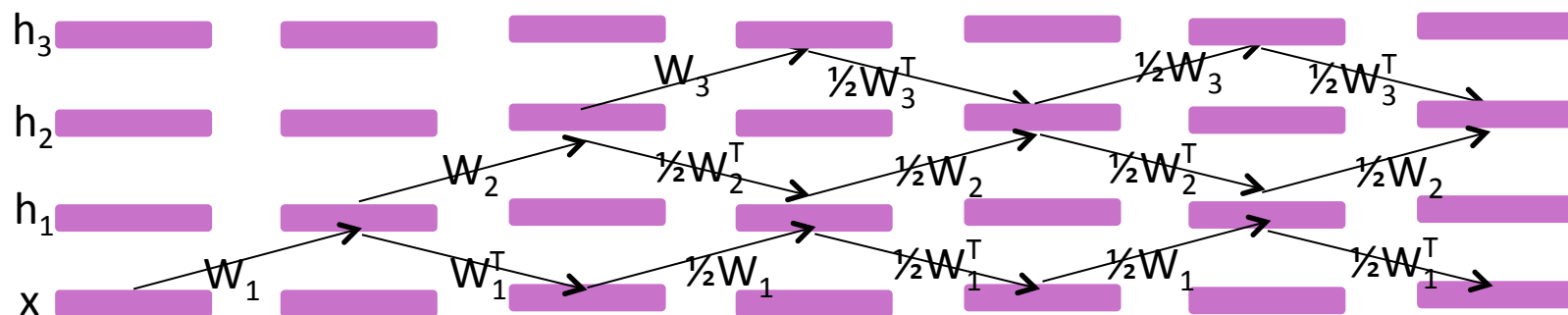

Stack of Auto-Encoders → Deep Generative Auto-Encoder

(Rifai et al ICML 2012)



- MCMC on top-level auto-encoder
 - $h_{t+1} = \text{encode}(\text{decode}(h_t)) + \sigma \text{ noise}$
where noise is $\text{Normal}(0, d/dh \text{ encode}(\text{decode}(h_t)))$
- Then deterministically propagate down with decoders

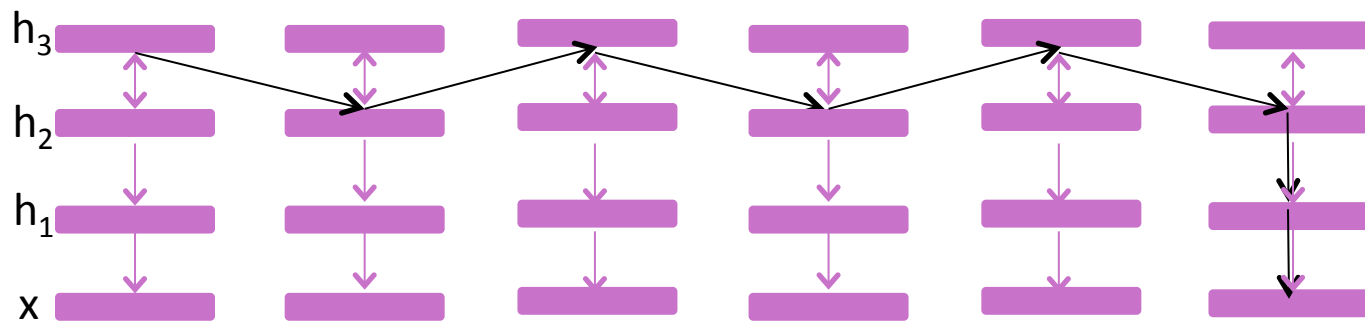

Generative Stochastic Networks (GSN)

(Bengio, Yao, Alain & Vincent, arxiv 2013; Bengio & Laufer, arxiv 2013)

- Recurrent parametrized stochastic computational graph that defines a transition operator for a Markov chain whose asymptotic distribution is implicitly estimated by the model
- Noise injected in input and hidden layers
- Trained to max. reconstruction prob. of example at each step
- **Example** structure inspired from the DBM Gibbs chain:

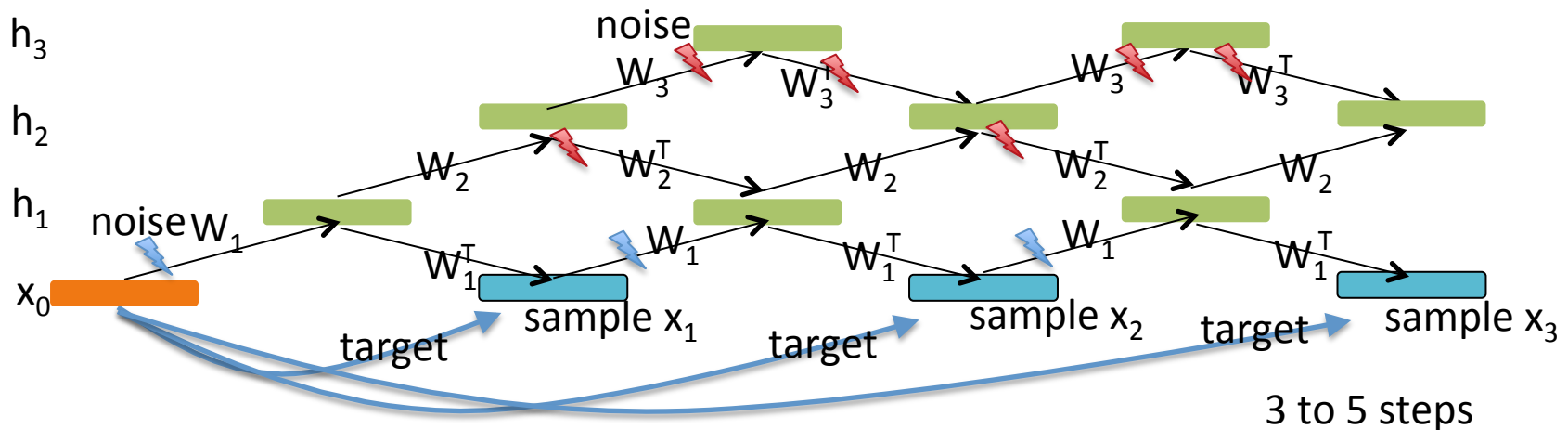

Denoising Auto-Encoder Markov Chain

- $\mathcal{P}(X)$: true data-generating distribution
- $\mathcal{C}(\tilde{X}|X)$: corruption process
- $P_{\theta_n}(X|\tilde{X})$: denoising auto-encoder trained with n examples X, \tilde{X} from $\mathcal{C}(\tilde{X}|X)\mathcal{P}(X)$, probabilistically “inverts” corruption
- T_n : Markov chain over X alternating $\tilde{X} \sim \mathcal{C}(\tilde{X}|X)$, $X \sim P_{\theta_n}(X|\tilde{X})$

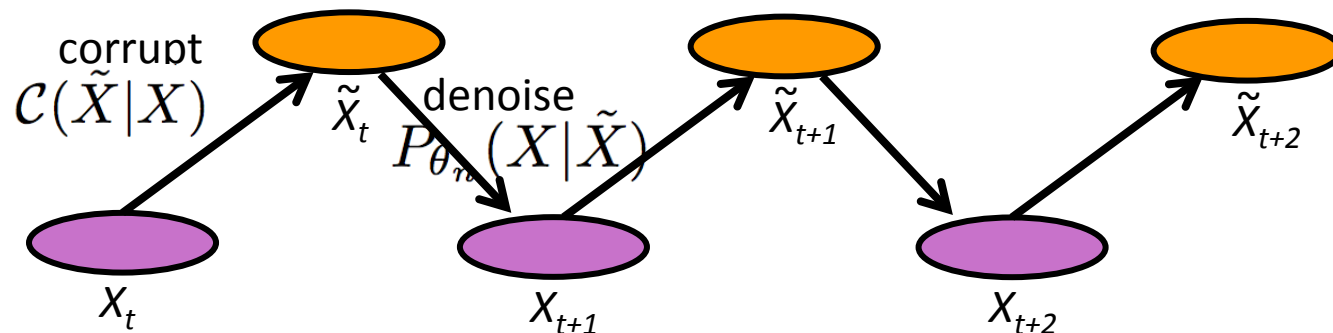

Previous Theoretical Results on Probabilistic Interpretation of Auto-Encoders

(Vincent 2011, Alain & Bengio 2013)

- Continuous X
- Gaussian corruption
- Noise $\sigma \rightarrow 0$
- Squared reconstruction error $\|r(X+\text{noise})-X\|^2$

$(r(X)-X)/\sigma^2$ estimates the score $d \log p(X) / dX$

New Theoretical Results

- Denoising AE are consistent estimators of the data-generating distribution through their Markov chain, so long as they consistently estimate the conditional denoising distribution and the Markov chain converges.

Making $P_{\theta_n}(X|\tilde{X})$ match $\mathcal{P}(X|\tilde{X})$ makes $\pi_n(X)$ match $\mathcal{P}(X)$

denoising distr. truth stationary distr. truth

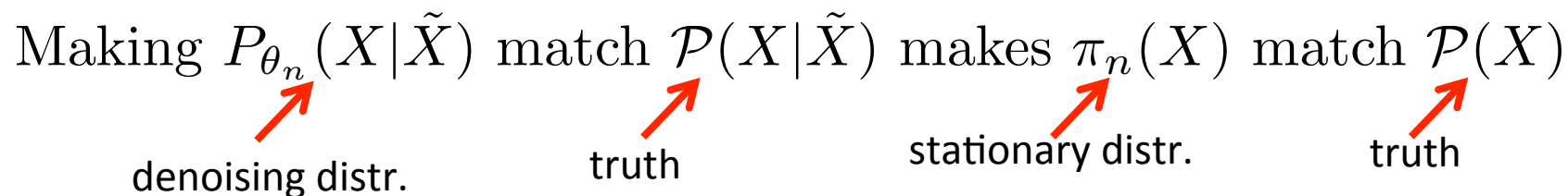

Generative Stochastic Networks (GSN)

- If we decompose the reconstruction probability into a parametrized noise-dependent part $\tilde{X} = f_{\theta_1}(X, Z)$ and a noise-independent part $P_{\theta_2}(X|\tilde{X})$, we also get a consistent estimator of the data generating distribution, if the chain converges.

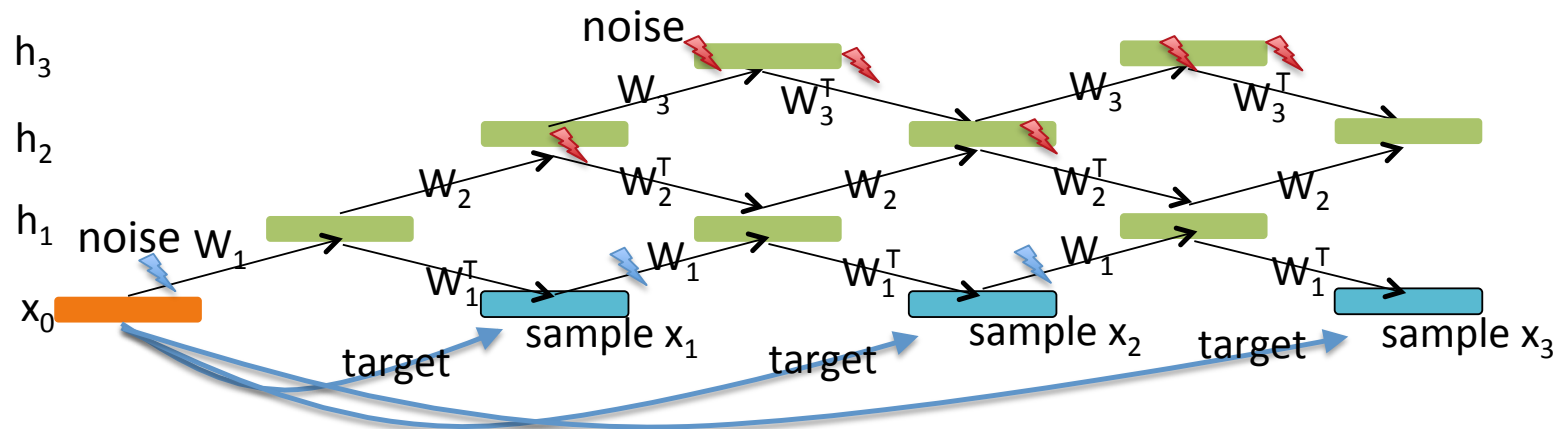

GSN Experiments: validating the theorem in a continuous non-parametric setting

- Continuous data, X in R^{10} , Gaussian corruption
- Reconstruction distribution = Parzen (mixture of Gaussians) estimator
- 5000 training examples, 5000 samples
- Visualize a pair of dimensions

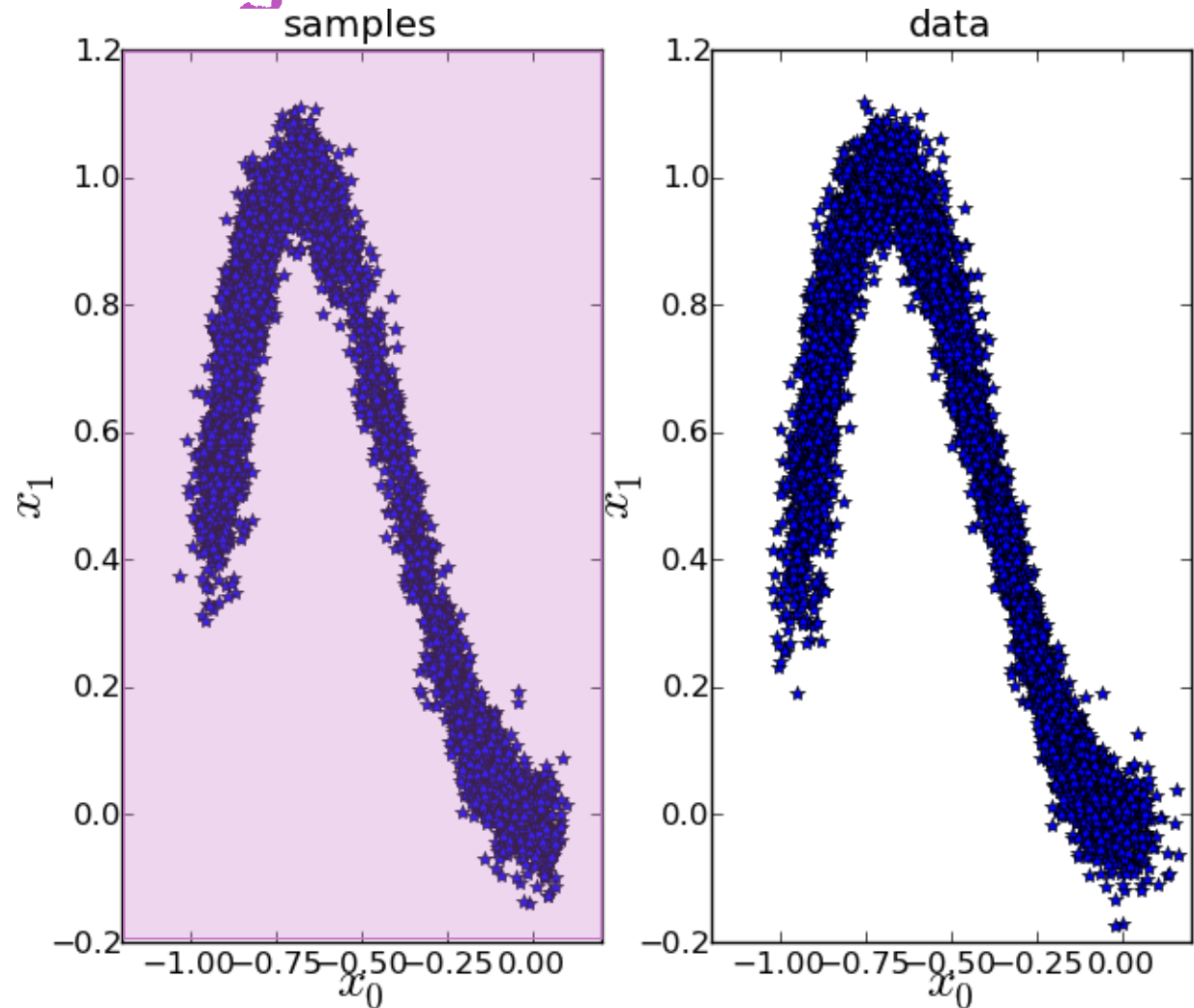

GSN Experiments: validating the theorem in a continuous non-parametric setting

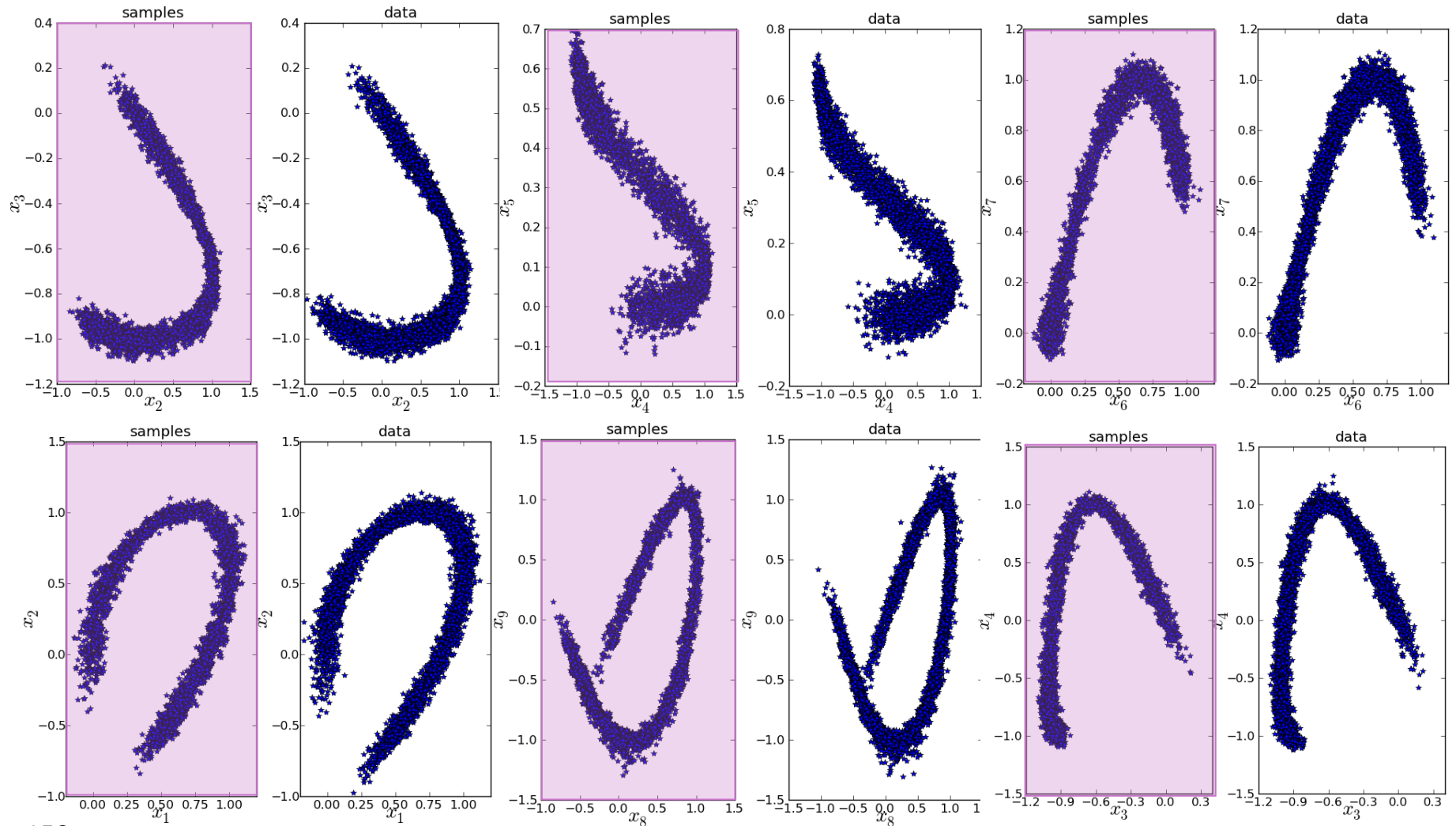

Shallow Model: Generalizing the Denoising Auto-Encoder Probabilistic Interpretation

- Classical denoising auto-encoder architecture, single hidden layer with noise only injected in input
- Factored Bernoulli reconstruction prob. distr.
- $\tilde{X} = f_{\theta_1}(X, Z) =$ parameter-less, salt-and-pepper noise on top of X

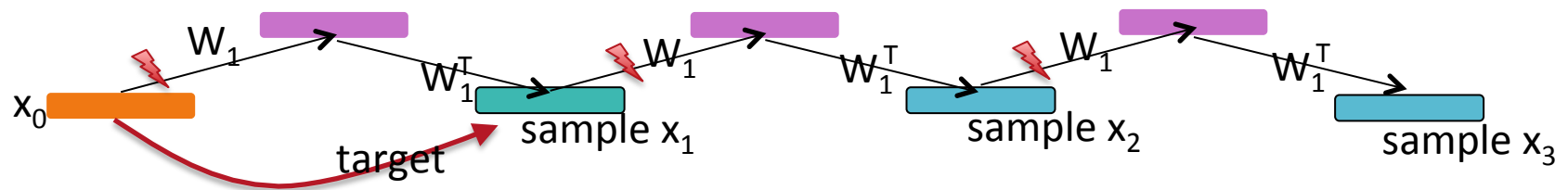

- *Generalizes (Alain & Bengio ICLR 2013): not just continuous r.v., any training criterion (as log-likelihood), not just Gaussian but any corruption (no need to be tiny to correctly estimate distribution).*

Experiments: Shallow vs Deep

- Shallow (DAE), no recurrent path at higher levels, state=X only

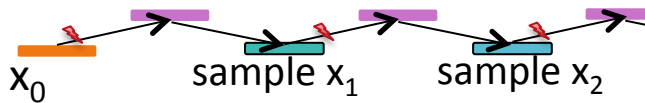

- Deep GSN:

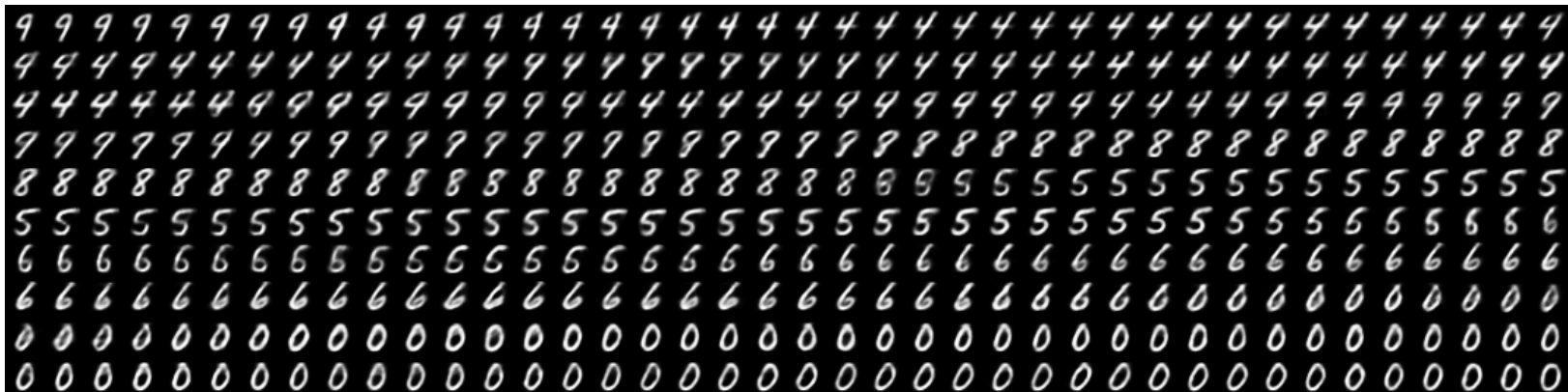
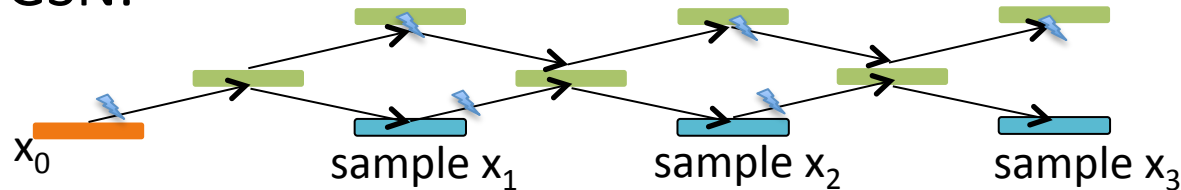

Quantitative Evaluation of Samples

- Previous procedure for evaluating samples (Breuleux et al 2011, Rifai et al 2012, Bengio et al 2013):
 - Generate 10000 samples from model
 - Use them as training examples for Parzen density estimator
 - Evaluate its log-likelihood on MNIST test data

	GSN-2	DAE	RBM	DBM-3	DBN-2	MNIST
LOG-LIKELIHOOD	214	-152	-244	32	138	24
STANDARD ERROR	1.1	2.2	54	1.9	2.0	1.6

Training examples
↓

Question Answering, Missing Inputs and Structured Output

- Once trained, a GSN can provably sample from any conditional over subsets of its inputs, so long as we use the conditional associated with the reconstruction distribution and clamp the right-hand side variables.

(Bengio & Laufer arXiv 2013)

Experiments: Structured Conditionals

- Stochastically fill-in missing inputs, sampling from the chain that generates the conditional distribution of the missing inputs given the observed ones (notice the fast burn-in!)



Not Just MNIST: experiments on TFD

- 3 hidden layer model, consecutive samples:

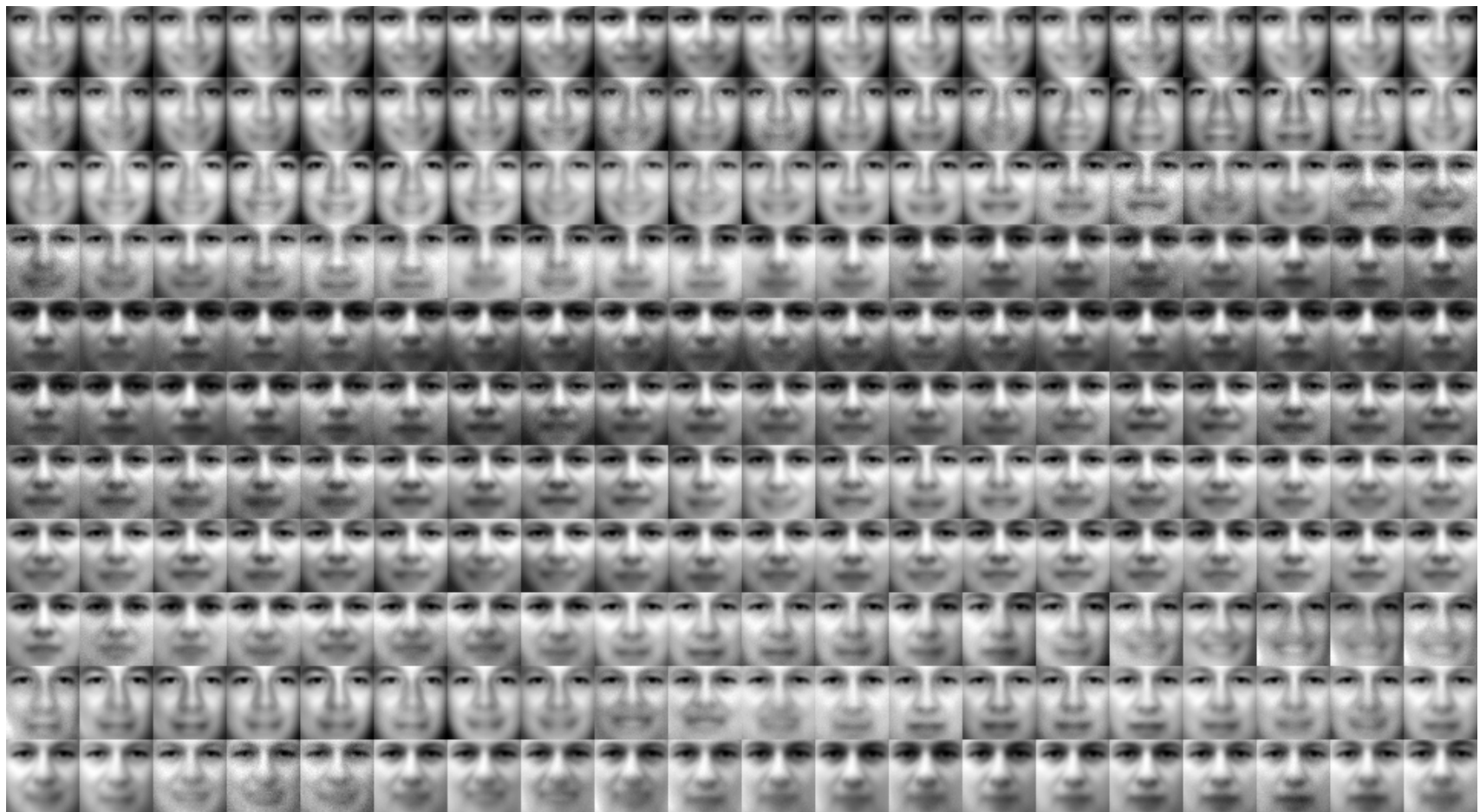

Part 3

Practical Considerations

Deep Learning Tricks of the Trade

- Y. Bengio (2013), “Practical Recommendations for Gradient-Based Training of Deep Architectures”
 - Unsupervised pre-training
 - Stochastic gradient descent and setting learning rates
 - Main hyper-parameters
 - Learning rate schedule
 - Early stopping
 - Minibatches
 - Parameter initialization
 - Number of hidden units
 - L1 and L2 weight decay
 - Sparsity regularization
 - Debugging
 - How to efficiently search for hyper-parameter configurations

Stochastic Gradient Descent (SGD)

- Gradient descent uses total gradient over all examples per update, SGD updates after only 1 or few examples:

$$\theta^{(t)} \leftarrow \theta^{(t-1)} - \epsilon_t \frac{\partial L(z_t, \theta)}{\partial \theta}$$

- L = loss function, z_t = current example, θ = parameter vector, and ϵ_t = learning rate.
- Ordinary gradient descent is a batch method, very slow, **should never be used**. 2nd order batch methods are being explored as an alternative but SGD with selected learning schedule remains the method to beat.

Learning Rates

- Simplest recipe: keep it fixed and use the same for all parameters.
- Collobert scales them by the inverse of square root of the fan-in of each neuron
- Better results can generally be obtained by allowing learning rates to decrease, typically in $O(1/t)$ because of theoretical convergence guarantees, e.g.,

$$\epsilon_t = \frac{\epsilon_0 \tau}{\max(t, \tau)}$$

with hyper-parameters ϵ_0 and τ .

- New papers on adaptive learning rates procedures (Schaul 2012, 2013), Adagrad (Duchi et al 2011), ADADELTA (Zeiler 2012)

Early Stopping

- Beautiful **FREE LUNCH** (no need to launch many different training runs for each value of hyper-parameter for #iterations)
- Monitor validation error during training (after visiting # of training examples = a multiple of validation set size)
- Keep track of parameters with best validation error and report them at the end
- If error does not improve enough (with some patience), stop.

Long-Term Dependencies



- In very deep networks such as **recurrent networks** (or possibly recursive ones), the gradient is a product of Jacobian matrices, each associated with a step in the forward computation. This can become very small or very large quickly [Bengio et al 1994], and the locality assumption of gradient descent breaks down.

$$L = L(s_T(s_{T-1}(\dots s_{t+1}(s_t, \dots))))$$
$$\frac{\partial L}{\partial s_t} = \frac{\partial L}{\partial s_T} \frac{\partial s_T}{\partial s_{T-1}} \dots \frac{\partial s_{t+1}}{\partial s_t}$$

- Two kinds of problems:
 - sing. values of Jacobians $> 1 \rightarrow$ gradients explode
 - or sing. values $< 1 \rightarrow$ gradients shrink & vanish

The Optimization Challenge in Deep / Recurrent Nets

- Higher-level abstractions require highly non-linear transformations to be learned
- Sharp non-linearities are difficult to learn by gradient
- Composition of many non-linearities = sharp non-linearity
- Exploding or vanishing gradients

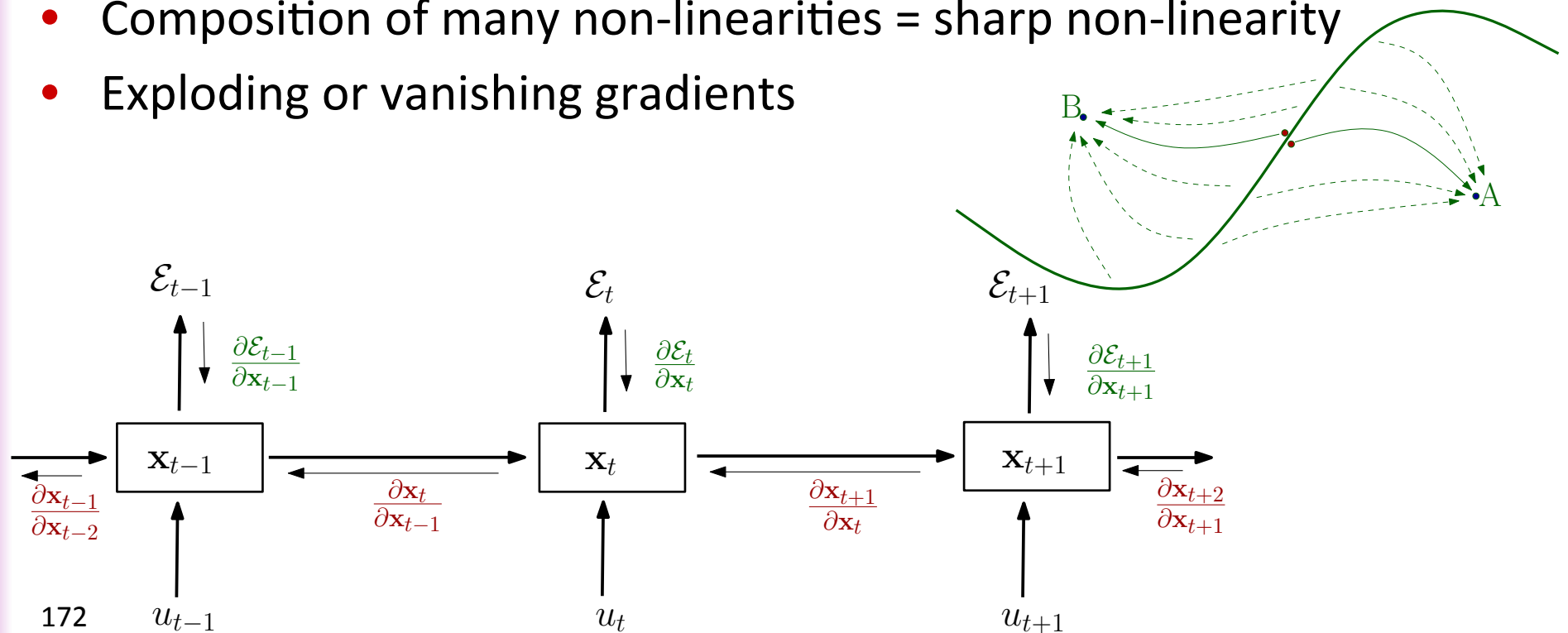

RNN Tricks

(Pascanu, Mikolov, Bengio, ICML 2013; Bengio, Boulanger & Pascanu, ICASSP 2013)

- Clipping gradients (avoid exploding gradients)
- Leaky integration (propagate long-term dependencies)
- Momentum (cheap 2nd order)
- Initialization (start in right ballpark avoids exploding/vanishing)
- Sparse Gradients (symmetry breaking)
- Gradient propagation regularizer (avoid vanishing gradient)
- LSTM self-loops (avoid vanishing gradient)

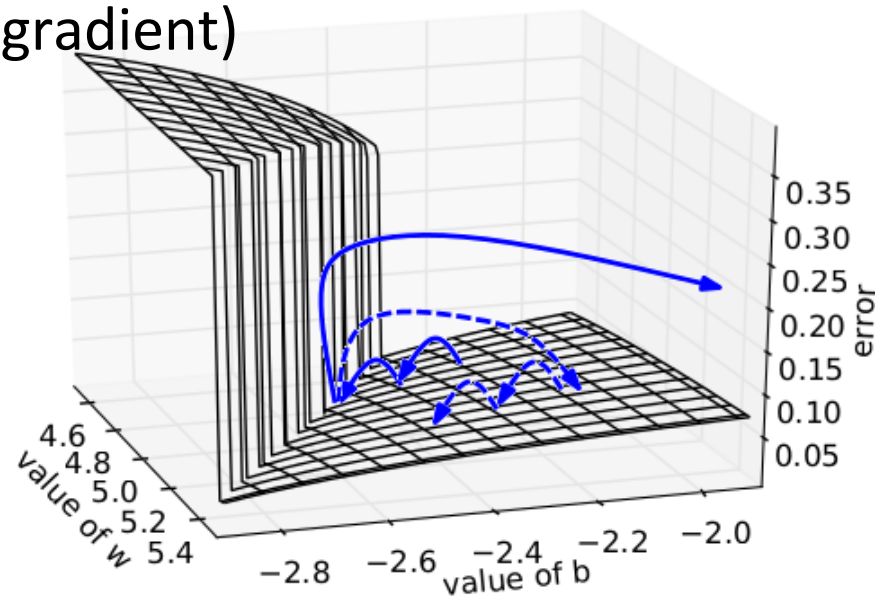
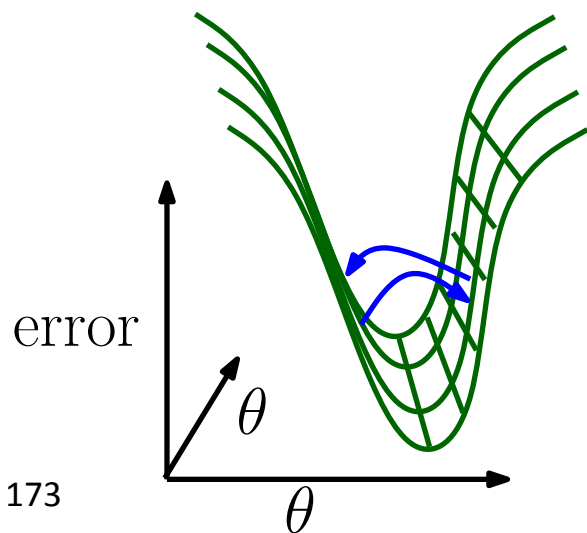

Long-Term Dependencies and Clipping Trick

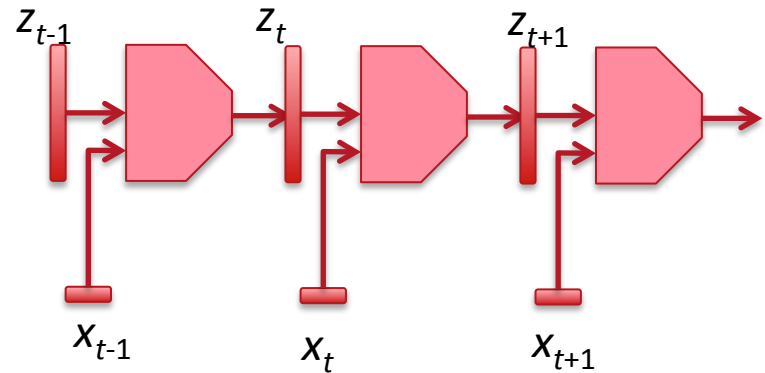

Trick first introduced by Mikolov is to clip gradients to a maximum NORM value.

Makes a big difference in Recurrent Nets ([Pascanu et al ICML 2013](#))

Allows SGD to compete with HF optimization on difficult long-term dependencies tasks. Helped to beat SOTA in text compression, language modeling, speech recognition.

Combining clipping to avoid gradient explosion and Jacobian regularizer to avoid gradient vanishing

- (Pascanu, Mikolov & Bengio, ICML 2013)

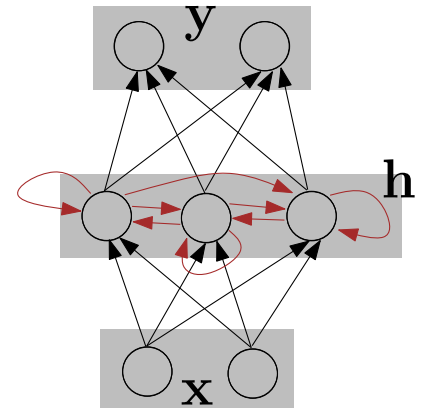
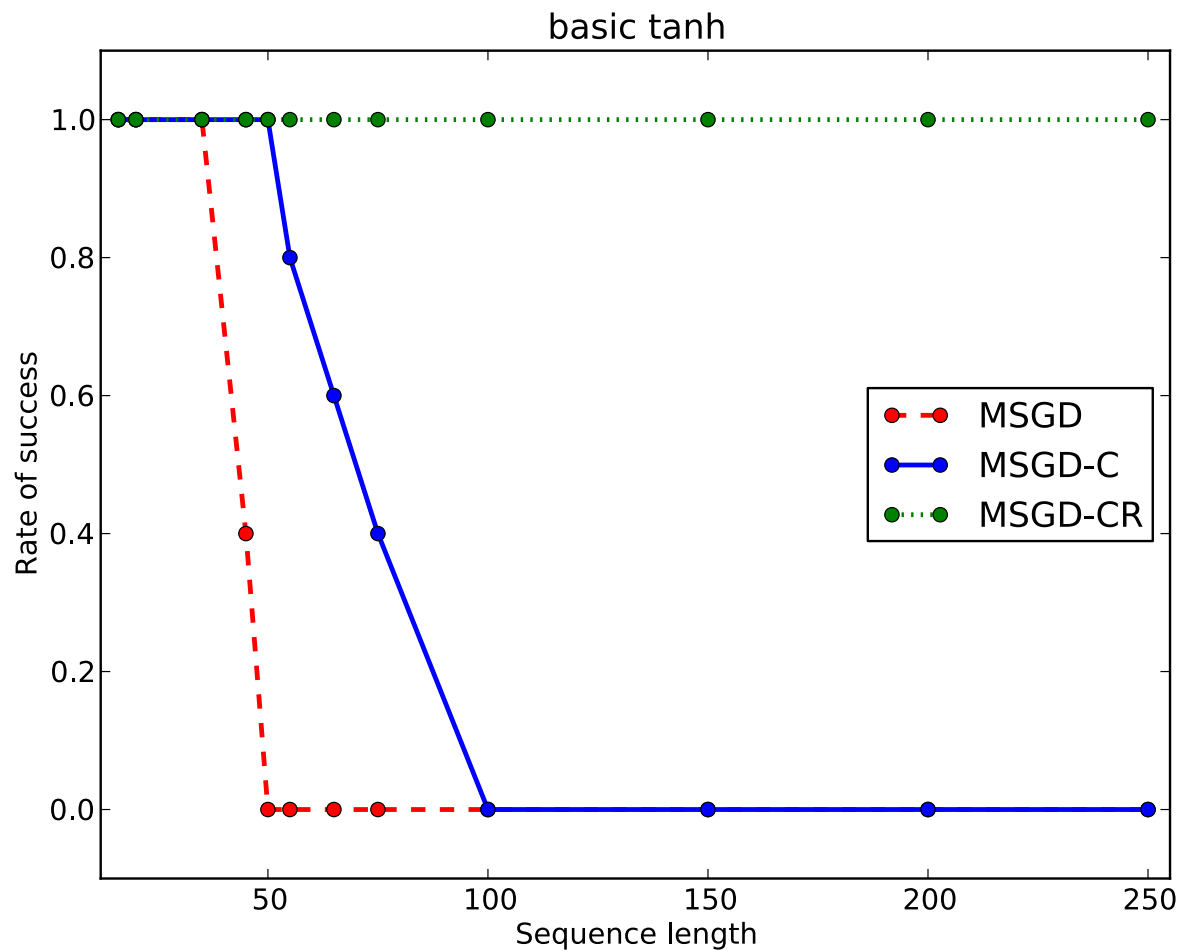

Normalized Initialization to Achieve Unity-Like Jacobian

Assuming $f'(act=0)=1$

To keep information flowing in both direction we would like to have the following properties.

- **Forward-propagation:**

$$\forall(i, i'), Var[z^i] = Var[z^{i'}] \Leftrightarrow \forall i, n_i Var[W^i] = 1$$

- **Back-propagation:**

$$\forall(i, i'), Var\left[\frac{\partial Cost}{\partial s^i}\right] = Var\left[\frac{\partial Cost}{\partial s^{i'}}\right] \Leftrightarrow \forall i, n_{i+1} Var[W^i] = 1$$

Possible compromise:

$$\forall i, Var[W^i] = \frac{2}{n_i + n_{i+1}} \quad (4)$$

This gives rise to proposed **normalized initialization** procedure:

$$W^i \sim U\left[-\frac{\sqrt{6}}{\sqrt{n_i + n_{i+1}}}, \frac{\sqrt{6}}{\sqrt{n_i + n_{i+1}}}\right] \quad (5)$$

Normalized Initialization with Variance-Preserving Jacobians

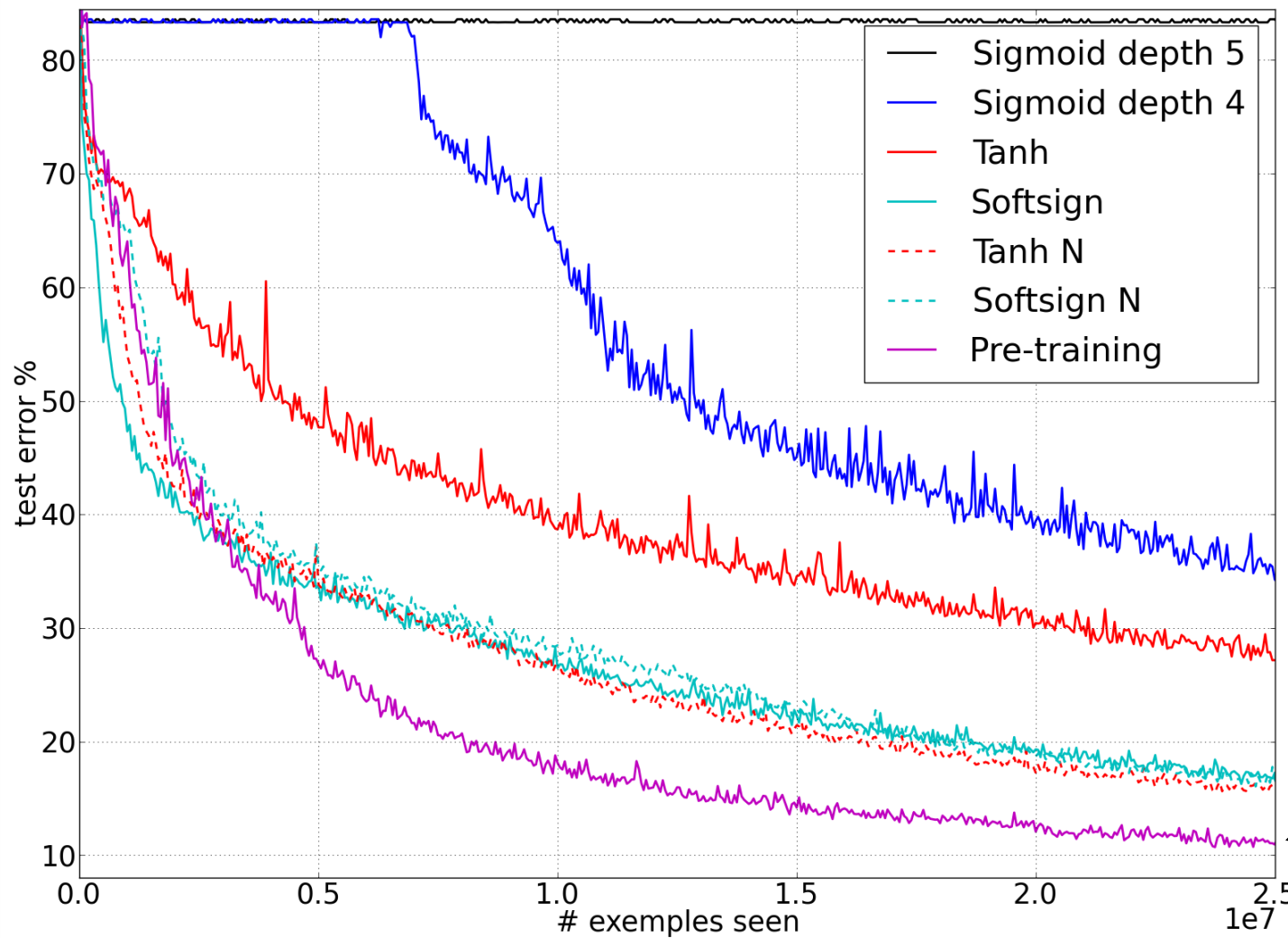

Unsupervised pre-training: Automatically variance-preserving!



Parameter Initialization

- Initialize hidden layer biases to 0 and output (or reconstruction) biases to optimal value if weights were 0 (e.g. mean target or inverse sigmoid of mean target).
- Initialize weights \sim Uniform(-r,r), r inversely proportional to fan-in (previous layer size) and fan-out (next layer size):

$$\sqrt{6 / (\text{fan-in} + \text{fan-out})}$$

for tanh units (and 4x bigger for sigmoid units)

(Glorot & Bengio AISTATS 2010)

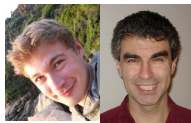

Handling Large Output Spaces

- Auto-encoders and RBMs reconstruct the input, which is sparse and high-dimensional; Language models have a huge output space (1 unit per word).

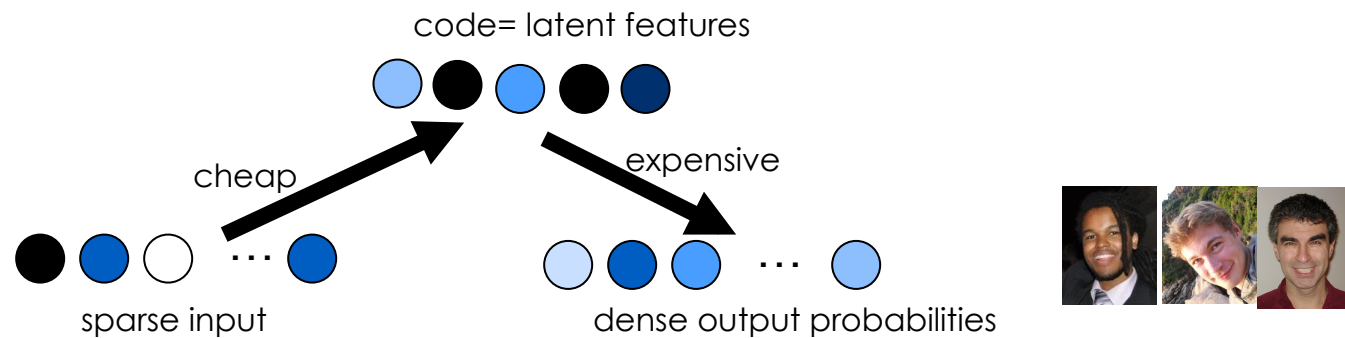

- (Dauphin et al, ICML 2011) Reconstruct the non-zeros in the input, and reconstruct as many randomly chosen zeros, + importance weights



- (Collobert & Weston, ICML 2008) sample a ranking loss
- Decompose output probabilities hierarchically (Morin & Bengio 2005; Blitzer et al 2005; Mnih & Hinton 2007,2009; Mikolov et al 2011)

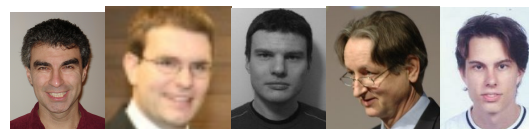
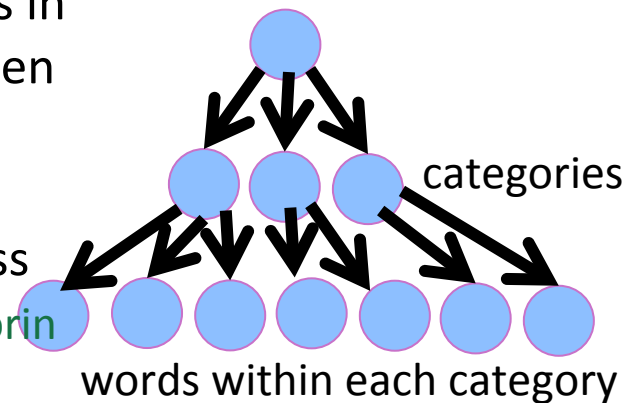

Automatic Differentiation

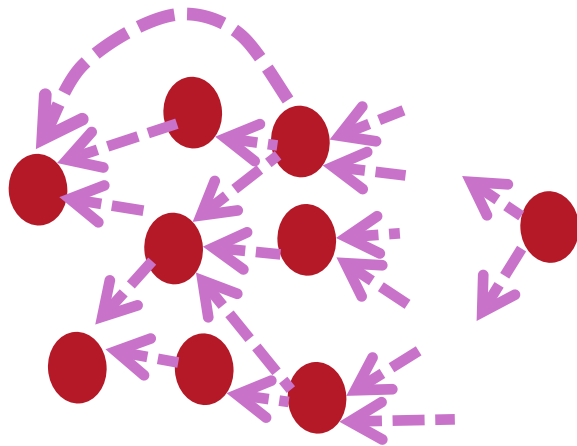
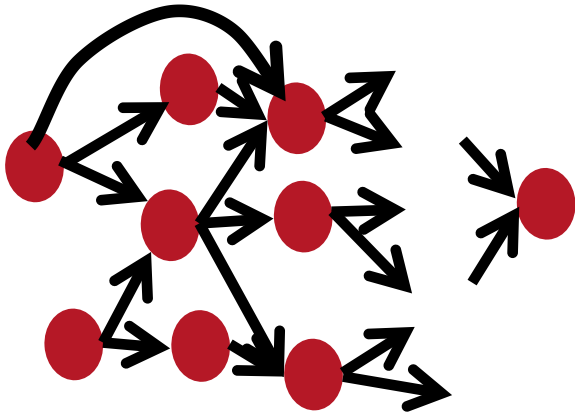

- Makes it easier to quickly and safely try new models.
- Theano Library (python) does it symbolically. Other neural network packages (Torch, Lush) can compute gradients for any given run-time value.

(Bergstra et al SciPy'2010)



Random Sampling of Hyperparameters

(Bergstra & Bengio 2012)



- Common approach: manual + grid search
- Grid search over hyperparameters: simple & wasteful
- Random search: simple & efficient
 - Independently sample each HP, e.g. $\text{l.rate} \sim \exp(\text{U}[\log(.1), \log(.0001)])$
 - Each training trial is iid
 - If a HP is irrelevant grid search is wasteful
 - More convenient: ok to early-stop, continue further, etc.

Grid Layout

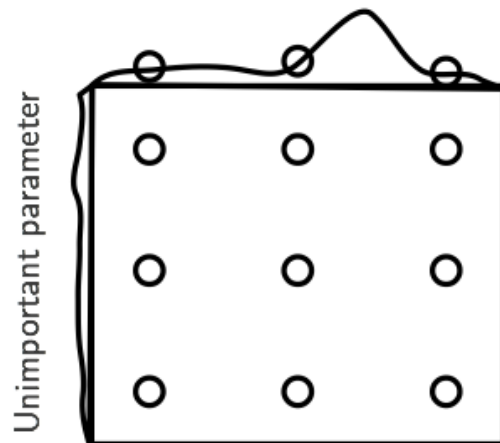

Important parameter

Random Layout

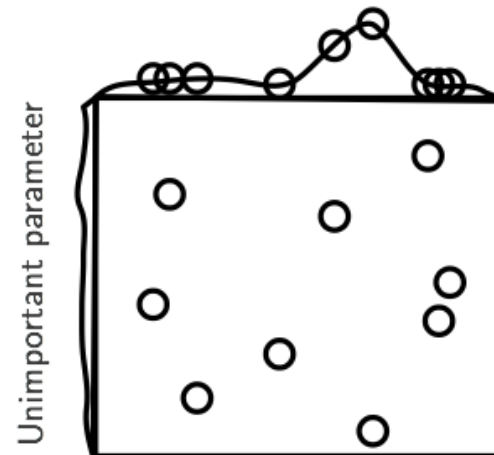

Important parameter

Sequential Model-Based Optimization of Hyper-Parameters

- (Hutter et al JAIR 2009; Bergstra et al NIPS 2011; Thornton et al arXiv 2012; Snoek et al NIPS 2012)
- Iterate
 - Estimate $P(\text{valid. err} \mid \text{hyper-params config } x, D)$
 - choose optimistic x , e.g. $\max_x P(\text{valid. err} < \text{current min. err} \mid x)$
 - train with config x , observe valid. err. v , $D \leftarrow D \cup \{(x, v)\}$

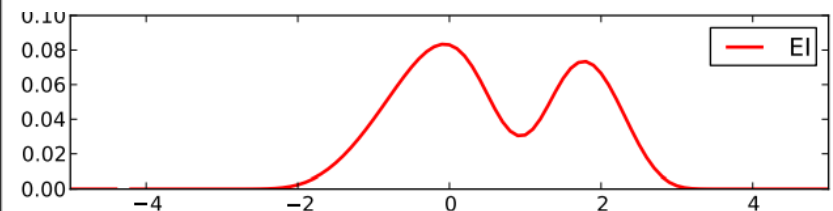
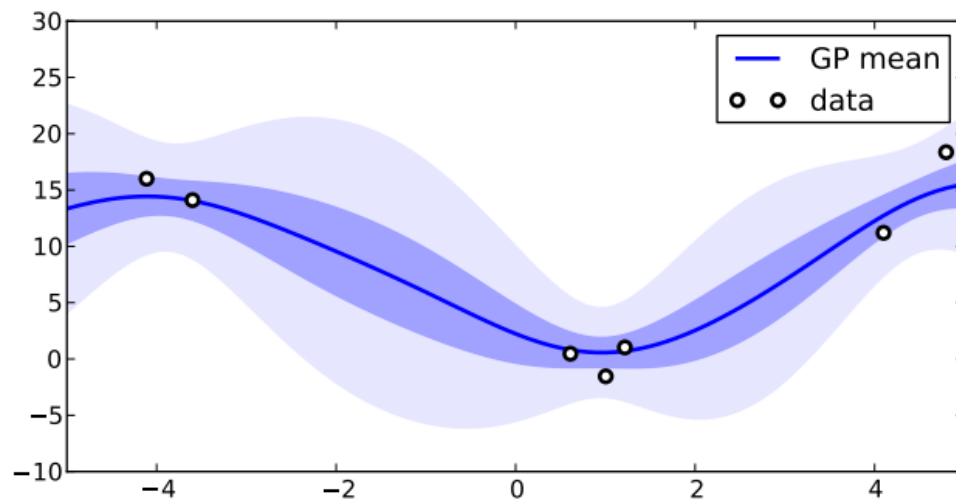

Discussion

CONCERNS

- Many algorithms and variants (burgeoning field)
- Hyper-parameters (layer size, regularization, possibly learning rate)
 - Use multi-core machines, clusters and **random sampling for cross-validation or sequential model-based optimization**

CONCERNS

- Slower to train than linear models
 - Only by a small constant factor, and much more compact than non-parametric (e.g. n-gram models or kernel machines)
 - Very fast during inference/test time (feed-forward pass is just a few matrix multiplies)
- Need more training data?
 - Can *handle and benefit from* more training data (esp. unlabeled), suitable for Big Data (Google trains nets with a billion connections, [Le et al, ICML 2012; Dean et al NIPS 2012])
 - Actually needs less ***labeled*** data

Concern: non-convex optimization

- Can initialize system with convex learner
 - Convex SVM
 - Fixed feature space
- Then optimize non-convex variant (add and tune learned features), can't be worse than convex learner

Part 4

Challenges & Questions

Why is Unsupervised Pre-Training Sometimes Working So Well?

- Regularization hypothesis:
 - Unsupervised component forces model close to $P(x)$
 - Representations good for $P(x)$ are good for $P(y|x)$
- Optimization hypothesis:
 - Unsupervised initialization near better local minimum of $P(y|x)$
 - Can reach lower local minimum otherwise not achievable by random initialization
 - Easier to train each layer using a layer-local criterion



(Erhan et al JMLR 2010)

Learning Trajectories in Function Space

- Each point a model in function space
- Color = epoch
- Top: trajectories w/o pre-training
- Each trajectory converges in different local min.
- No overlap of regions with and w/o pre-training

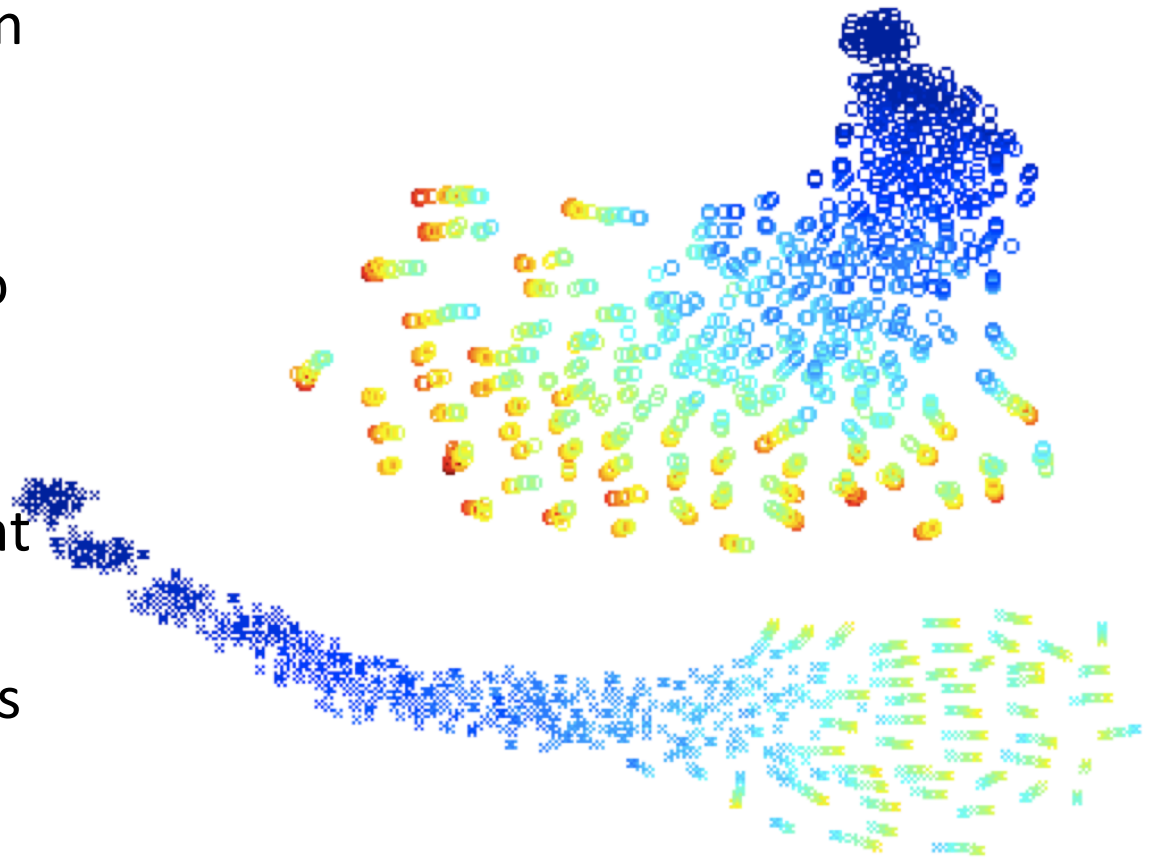

Learning Trajectories in Function Space

- Each trajectory converges in different local min.
- With ISOMAP, try to preserve geometry: pretrained nets converge near each other (less variance)
- Good answers = worse than a needle in a haystack (learning dynamics)

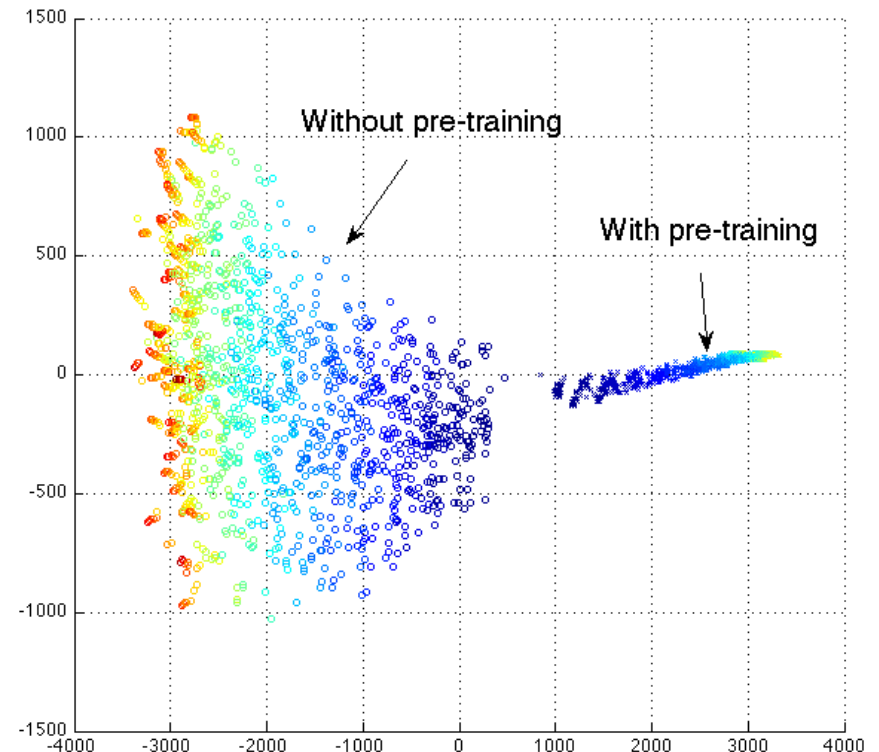

Deep Learning Challenges

(Bengio, arxiv 1305.0445 Deep Learning of representations: Looking forward)

- Computational Scaling
- Optimization & Underfitting
- Approximate Inference & Sampling
- Disentangling Factors of Variation
- Reasoning & One-Shot Learning of Facts

Challenge: Computational Scaling

- Recent breakthroughs in speech, object recognition and NLP hinged on faster computing, GPUs, and large datasets
- A 100-fold speedup is possible without waiting another 10yrs?
 - Challenge of distributed training
 - Challenge of conditional computation

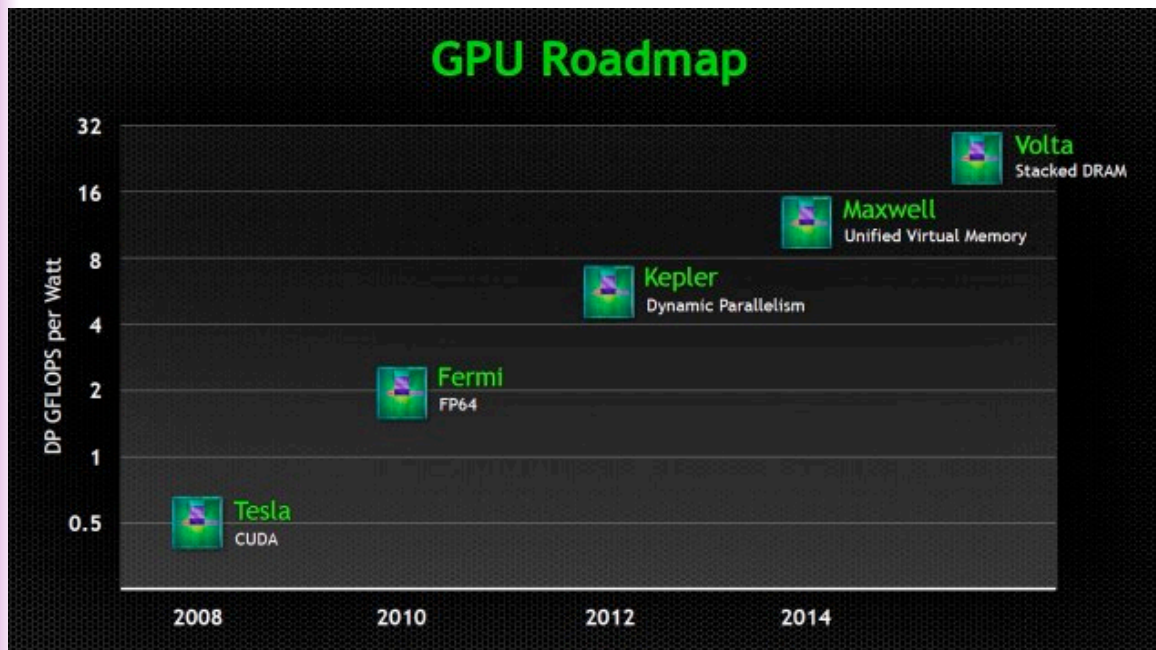

Conditional Computation: only visit a small fraction of parameters / example

- Deep nets vs decision trees
- Hard mixtures of experts
- Conditional computation for deep nets: sparse distributed gaters selecting combinatorial subsets of a deep net
- Challenges:
 - Back-prop through hard decisions
 - Gated architectures exploration
- Symmetry breaking to reduce ill-conditioning

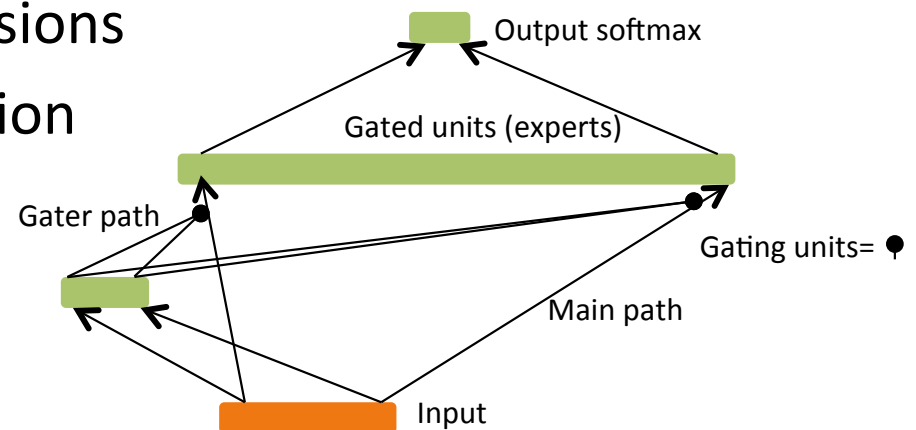

Distributed Training

- Minibatches (too large = slow down)
- Large minibatches + 2nd order methods
- Asynchronous SGD (Bengio et al 2003, Le et al ICML 2012, Dean et al NIPS 2012)
 - Bottleneck: sharing weights/updates among nodes
- New ideas:
 - Low-resolution sharing only where needed
 - Specialized conditional computation (each computer specializes in updates to some cluster of gated experts, and prefers examples which trigger these experts)

Optimization & Underfitting

- On large datasets, major obstacle is underfitting
- **Marginal utility** of wider MLPs decreases quickly below memorization baseline

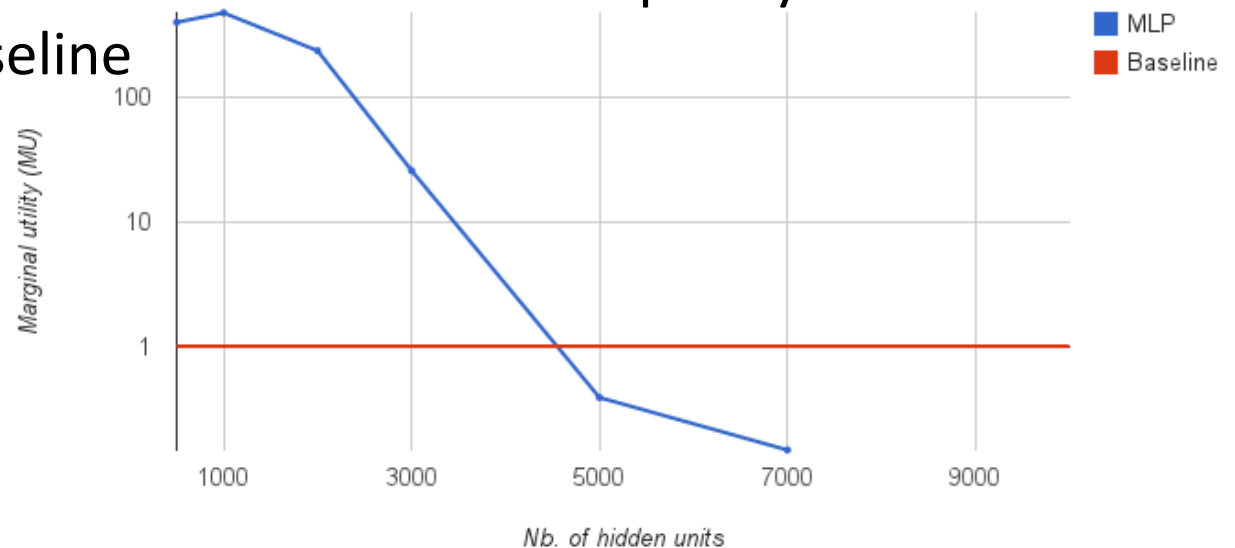

- Current limitations: local minima or ill-conditioning?
- Adaptive learning rates and stochastic 2nd order methods
- Conditional comp. & sparse gradients → better conditioning: when some gradients are 0, many cross-derivatives are also 0.

MCMC Sampling Challenges

- Burn-in
 - Going from an unlikely configuration to likely ones



- **Mixing**

- Local: auto-correlation between successive samples



- Global: **mixing between major “modes”**

challenge



For gradient & inference: More difficult to mix with better trained models

- Early during training, density smeared out, mode bumps overlap

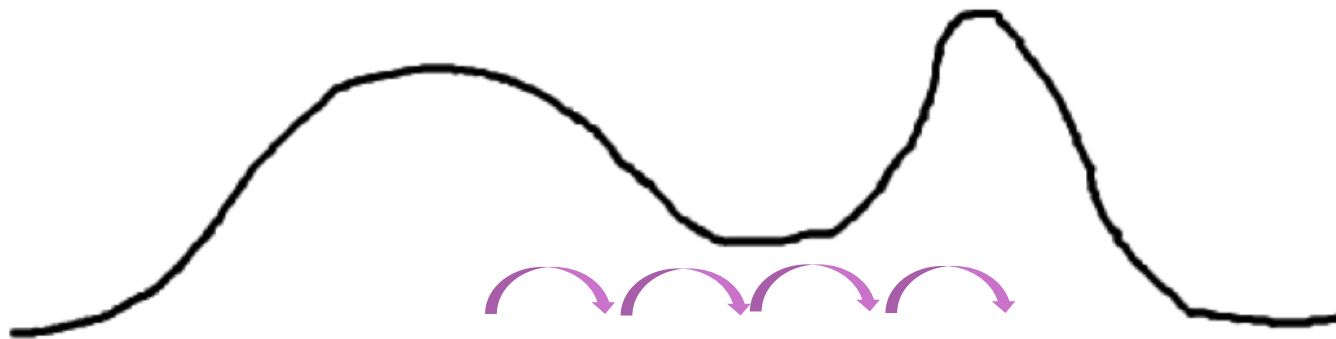

- Later on, hard to cross empty voids between modes

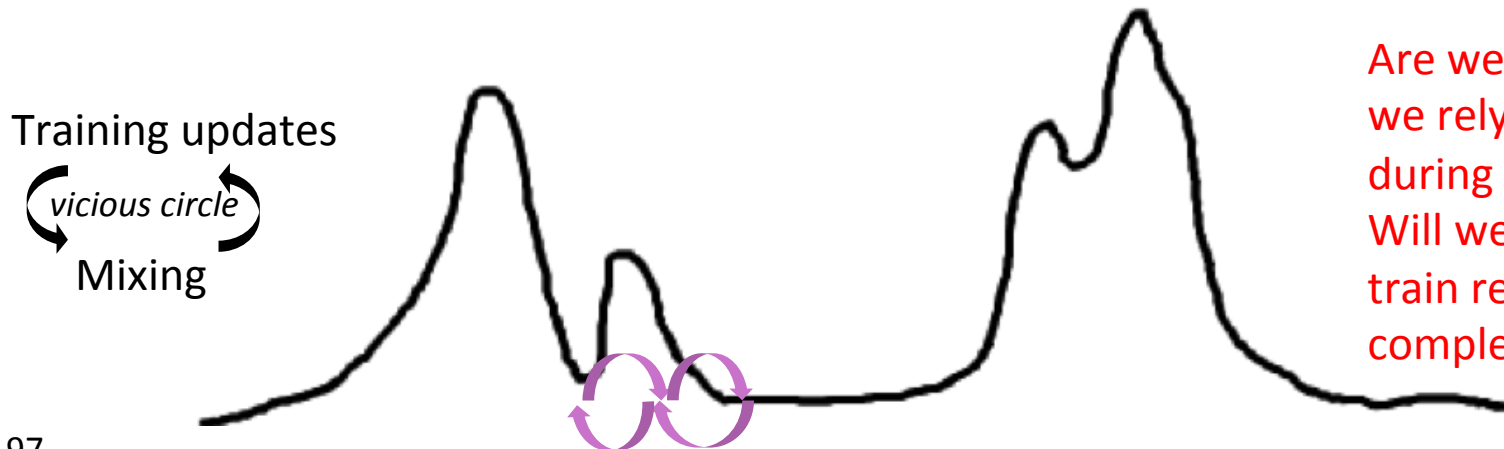

Are we doomed if
we rely on MCMC
during training?
Will we be able to
train really large &
complex models?

Poor Mixing: Depth to the Rescue

(Bengio et al ICML 2013)

- Sampling from DBNs and stacked Contractive Auto-Encoders:
 1. MCMC sampling from top layer model
 2. Propagate top-level representations to input-level repr.
- Deeper nets visit more modes (classes) faster

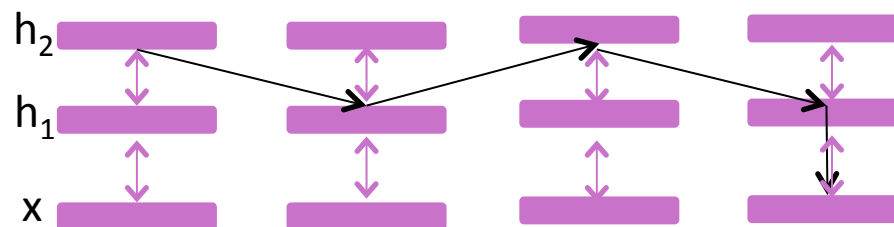

Space-Filling in Representation-Space

- High-probability samples fill more the convex set between them when viewed in the learned representation-space, making the empirical distribution more uniform and unfolding manifolds

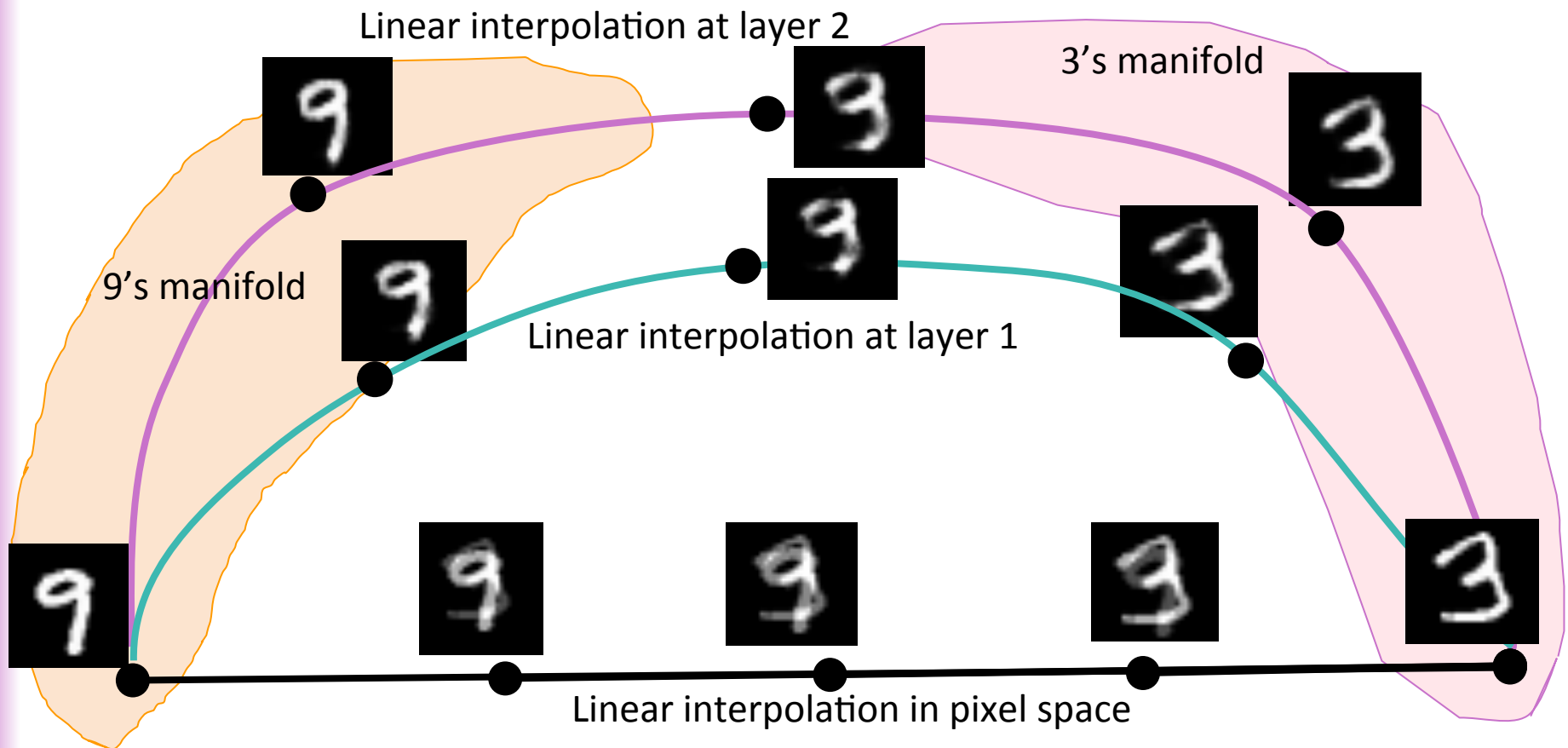

Poor Mixing: Depth to the Rescue

- Deeper representations \rightarrow abstractions \rightarrow disentangling
- E.g. reverse video bit, class bits in learned representations: easy to Gibbs sample between modes at abstract level
- Hypotheses tested and not rejected:
 - more abstract/disentangled representations unfold manifolds and fill more the space

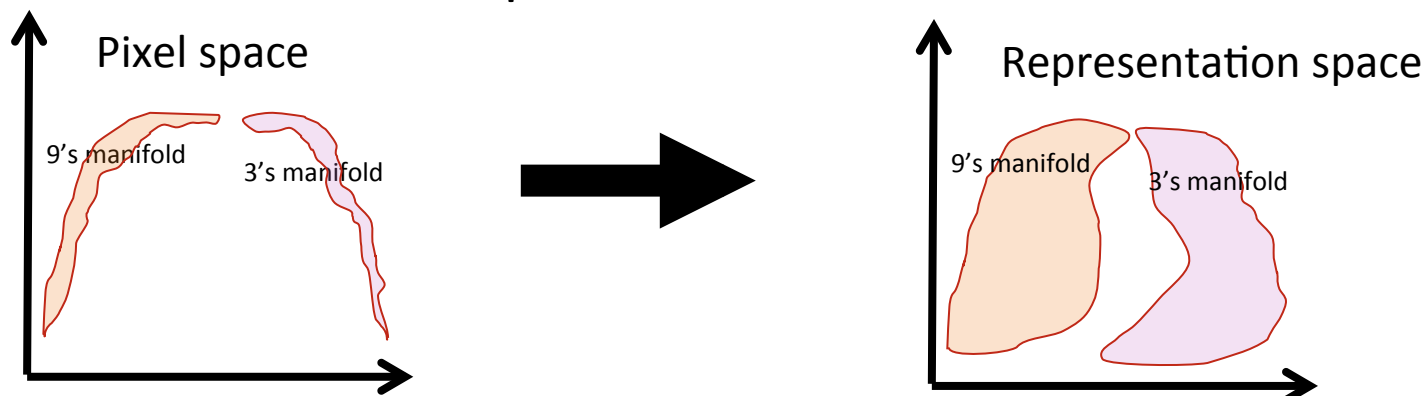

- can be exploited for better mixing between modes

Inference Challenges

- Many latent variables involved in understanding complex inputs (e.g. in NLP: sense ambiguity, parsing, semantic role)
- Almost any inference mechanism can be combined with deep learning
- See [Bottou, LeCun, Bengio 97], [Graves 2012]



- Complex inference can be hard (exponentially) and needs to be approximate → learn to perform inference

Inference & Sampling

- Currently for unsupervised learning & structured output models
- $P(h|x)$ intractable because of many important modes
- MAP, Variational, MCMC approximations limited to 1 or few modes

- Approximate inference can hurt learning

(Kulesza & Pereira NIPS'2007)

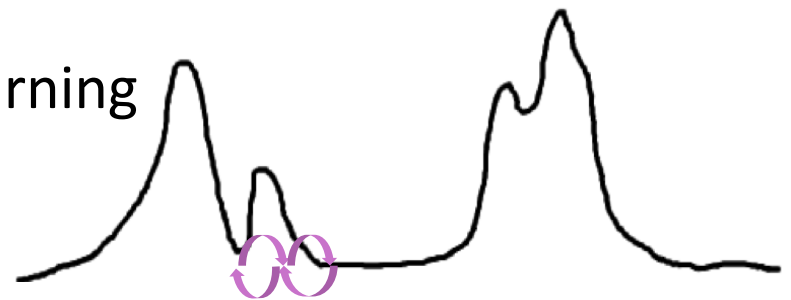

- Mode mixing harder as training progresses

(Bengio et al ICML 2013)

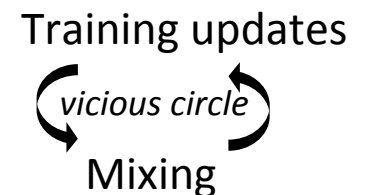

Latent Variables Love-Hate Relationship

- GOOD! **Appealing**: model explanatory factors h
- BAD! Exact inference? Nope. Just **Pain**.
too many possible configurations of h
- WORSE! Each learning step usually requires inference and/or sampling from $P(h, x)$

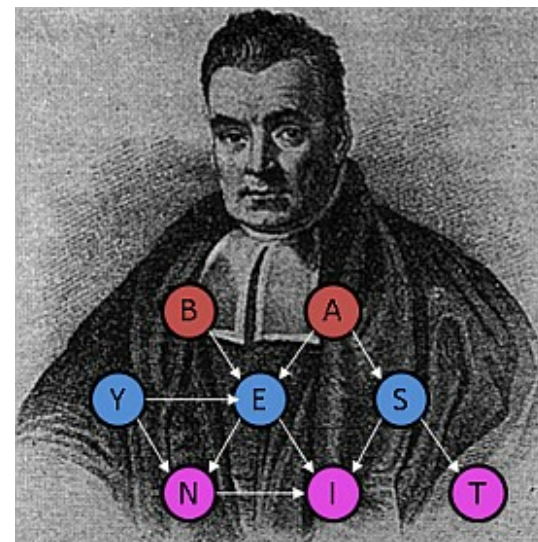

Anonymous Latent Variables

- *No pre-assigned semantics*
- Learning **discovers** underlying factors,
e.g., PCA discovers leading directions of variations
- Increases expressiveness of $P(\mathbf{x}) = \sum_h P(\mathbf{x}, h)$
- Universal approximators, e.g. for RBMs
(Le Roux & Bengio, Neural Comp. 2008)

Approximate Inference

- **MAP**
 - $h^* \equiv \operatorname{argmax}_h P(h|\mathbf{x}) \rightarrow$ assume 1 dominant mode
- **Variational**
 - Look for tractable $Q(h)$ minimizing $KL(Q(\cdot) || P(\cdot|\mathbf{x}))$
 - Q is either factorial or tree-structured
 - \rightarrow strong assumption
- **MCMC**
 - Setup Markov chain asymptotically sampling from $P(h|\mathbf{x})$
 - Approx. marginalization through MC avg over few samples
 - \rightarrow assume a few dominant modes
- *Approximate inference can seriously hurt learning*
(Kulesza & Pereira NIPS'2007)

Learned Approximate Inference

1. *Construct a computational graph corresponding to inference*
 - Loopy belief prop. (Ross et al CVPR 2011, Stoyanov et al 2011)
 - Variational mean-field (Goodfellow et al, ICLR 2013)
 - MAP (Kavukcuoglu et al 2008, Gregor & LeCun ICML 2010)
2. *Optimize parameters wrt criterion of interest, possibly decoupling from the generative model's parameters*

Learning can compensate for the inadequacy of approximate inference, taking advantage of specifics of the data distribution

However: Potentially Huge Number of Modes in Posterior $P(h|x)$

- Foreign speech utterance example, y =answer to question:
 - 10 word segments
 - 100 plausible candidates per word
 - 10^6 possible segmentations
 - Most configurations (999999/1000000) implausible
 - → 10^{20} high-probability modes
- **All known approximate inference scheme may break down if the posterior has a huge number of modes (fails MAP & MCMC) and not respecting a variational approximation (fails variational)**

Hint

- Deep neural nets learn good $P(y|\mathbf{x})$ classifiers even if there are potentially many true latent variables involved
- Exploits structure in $P(y|\mathbf{x})$ that persist even after summing h
- But how do we generalize this idea to full joint-distribution learning and answering any question about these variables, not just one?

Learning Computational Graphs

- Deep **Stochastic Generative Networks** (GSNs) trainable by backprop (Bengio & Laufer, arxiv 1306.1091)
- **Avoid any explicit latent variables whose marginalization is intractable, instead train a stochastic computational graph that generates the right {conditional} distribution.**

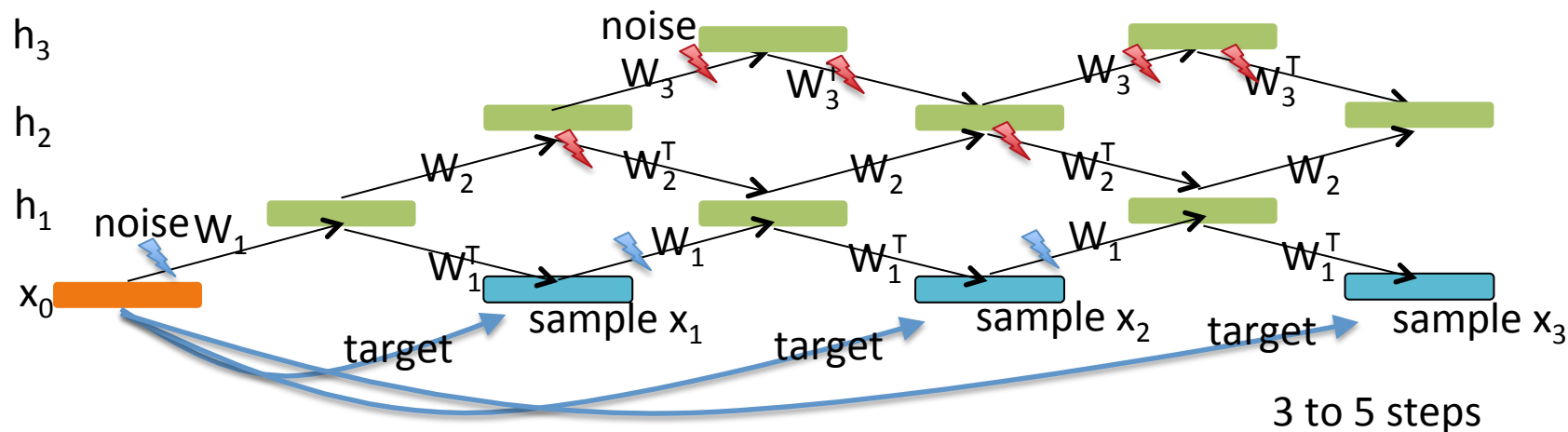

Theoretical Results

- The Markov chain associated with a denoising auto-encoder is a consistent estimator of the data generating distribution (if the chain converges)
- Same thing for Generative Stochastic Networks (so long as the reconstruction probability has enough expressive power to learn the required conditional distribution).

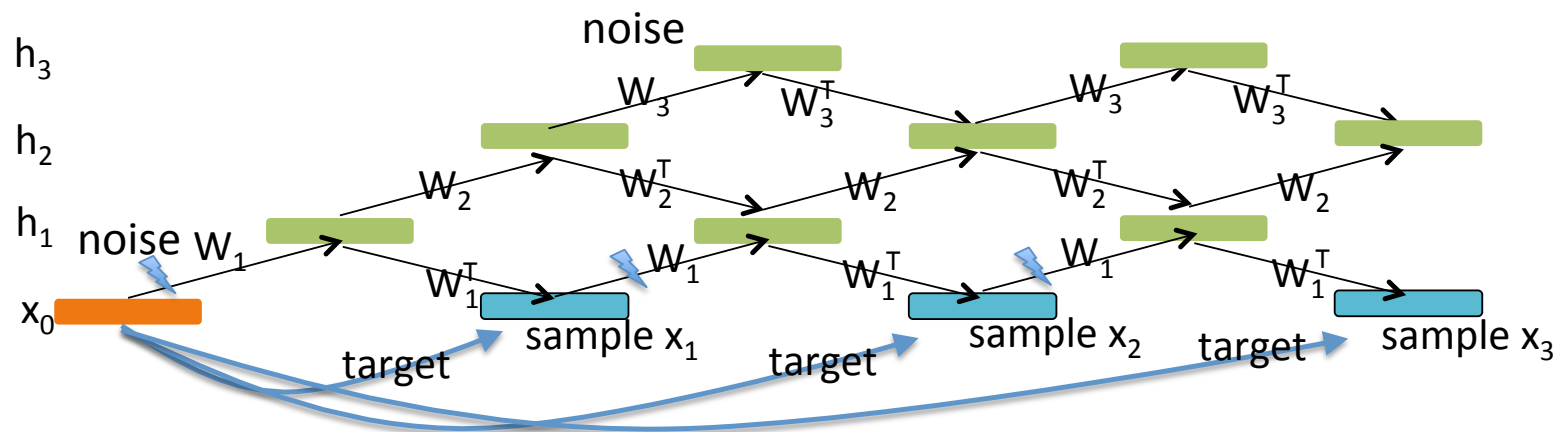

GSN Experiments: validating the theorem in a continuous non-parametric setting

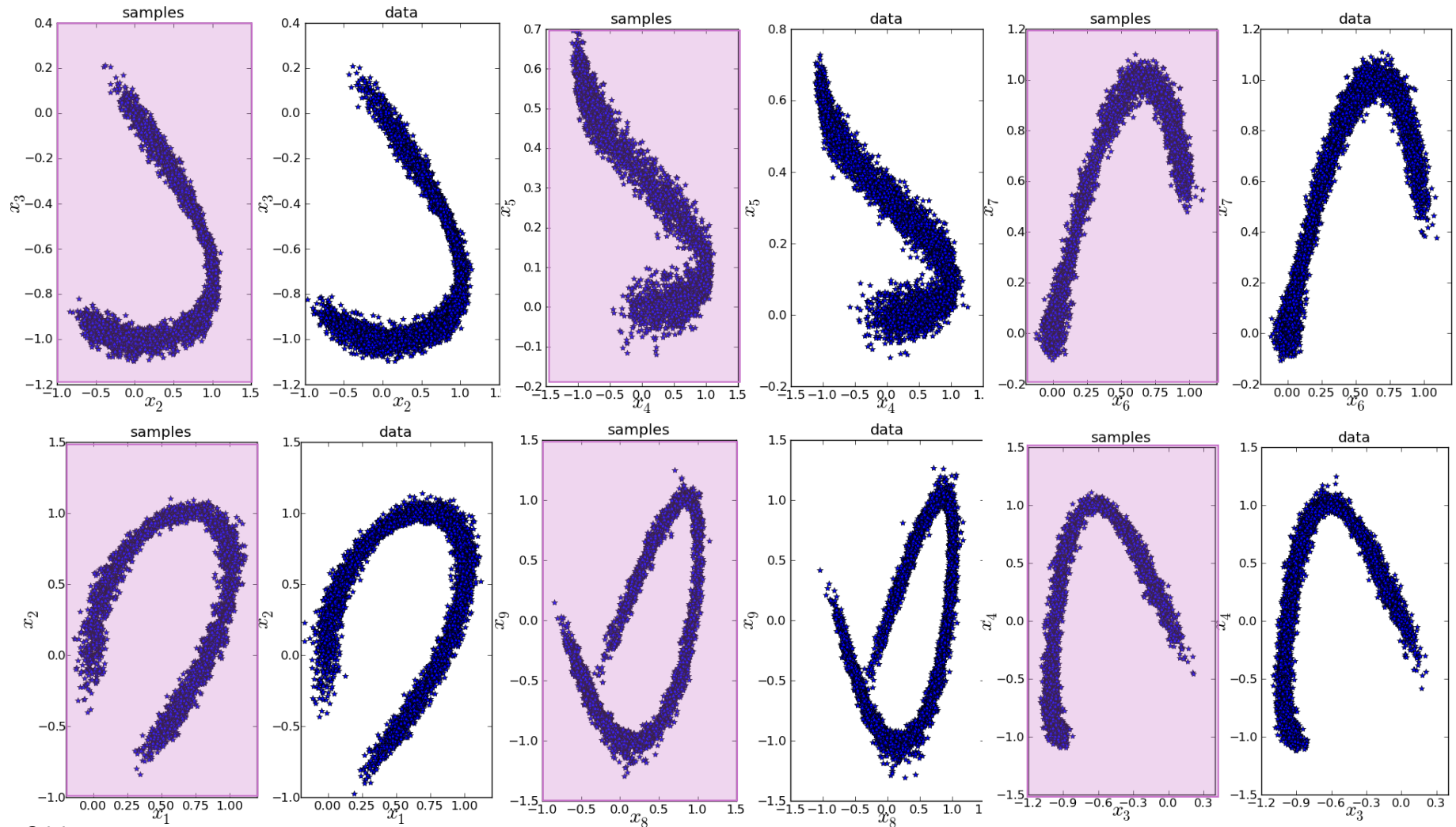

GSN Experiments: Consecutive Samples

Filling-in the LHS

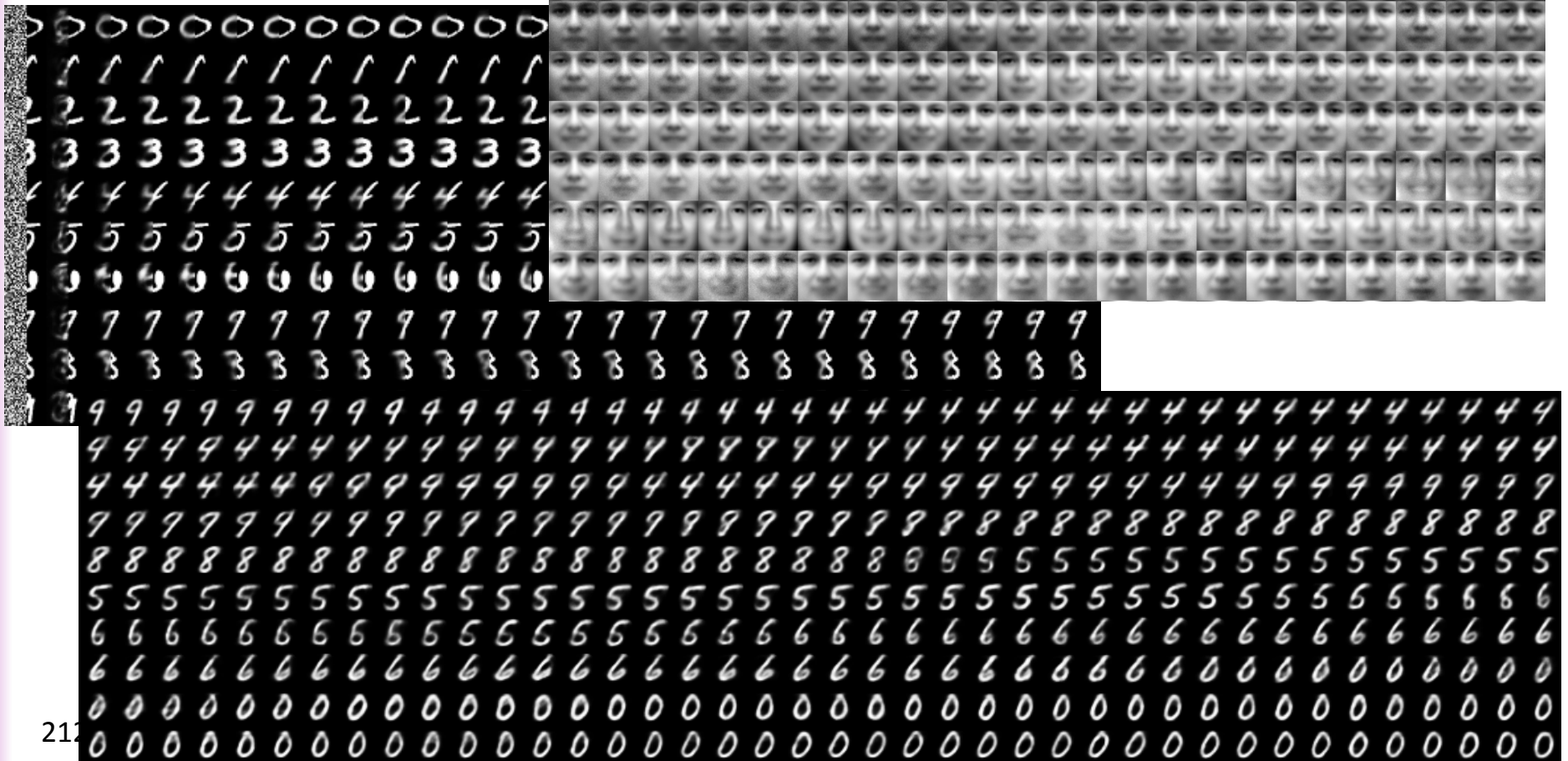

The Challenge of Disentangling Underlying Factors

- Good disentangling →
 - figure out the underlying structure of the data
 - avoid curse of dimensionality
 - mix better between modes
- How to obtained better disentangling????



Learning Multiple Levels of Abstraction

- The big payoff of deep learning is to allow learning higher levels of abstraction
- Higher-level abstractions disentangle the factors of variation, which allows much easier generalization and transfer

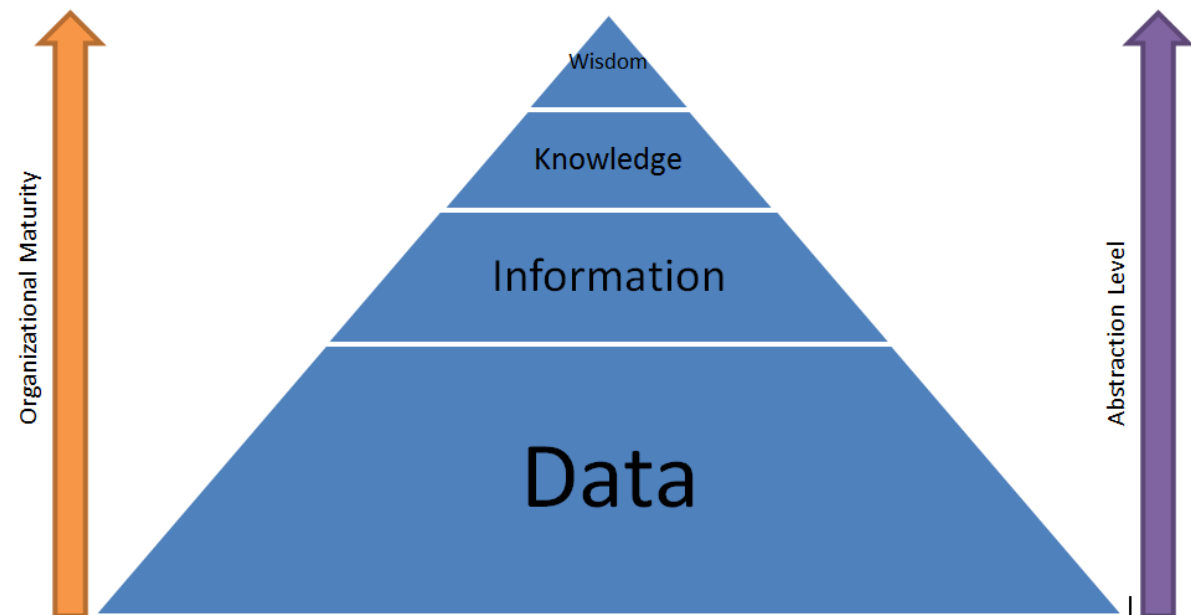

If Time Permits...

Issue: **underfitting** due to combinatorially many poor *effective* local minima

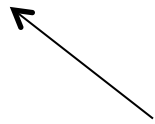

where the optimizer gets stuck

Culture vs Effective Local Minima

Bengio 2013 (also arXiv 2012)

Hypothesis 1

- When the brain of a single biological agent learns, it performs an approximate optimization with respect to some endogenous objective.

Hypothesis 2

- When the brain of a single biological agent learns, it relies on approximate local descent in order to gradually improve itself.

Theoretical and experimental results on deep learning suggest:

Hypothesis 3

- Higher-level abstractions in brains are represented by deeper computations (going through more areas or more computational steps in sequence over the same areas).

Hypothesis 4

- Learning of a single human learner is limited by *effective* local minima.

Possibly due to ill-conditioning, but behaves like local min

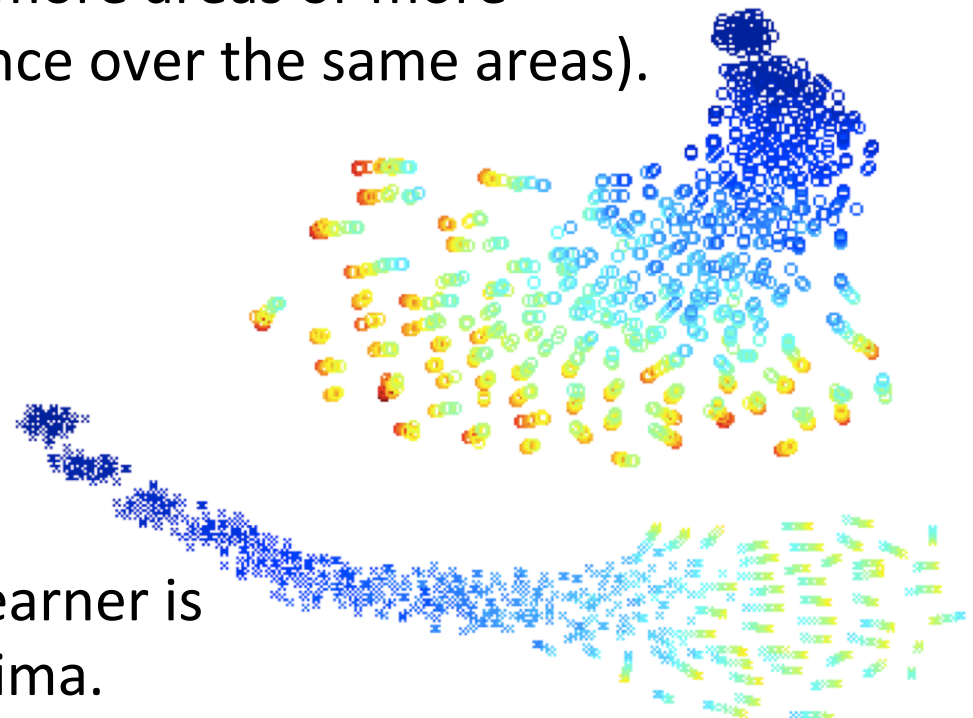

Hypothesis 5

- A single human learner is unlikely to discover high-level abstractions by chance because these are represented by a deep sub-network in the brain.

Hypothesis 6

Curriculum learning
(Bengio et al ICML 2009)

- A human brain can learn high-level abstractions if guided by the signals produced by other humans, which act as hints or indirect supervision for these high-level abstractions.

Supporting evidence: (Gulcehre & Bengio ICLR 2013)

How is one brain transferring abstractions to another brain?

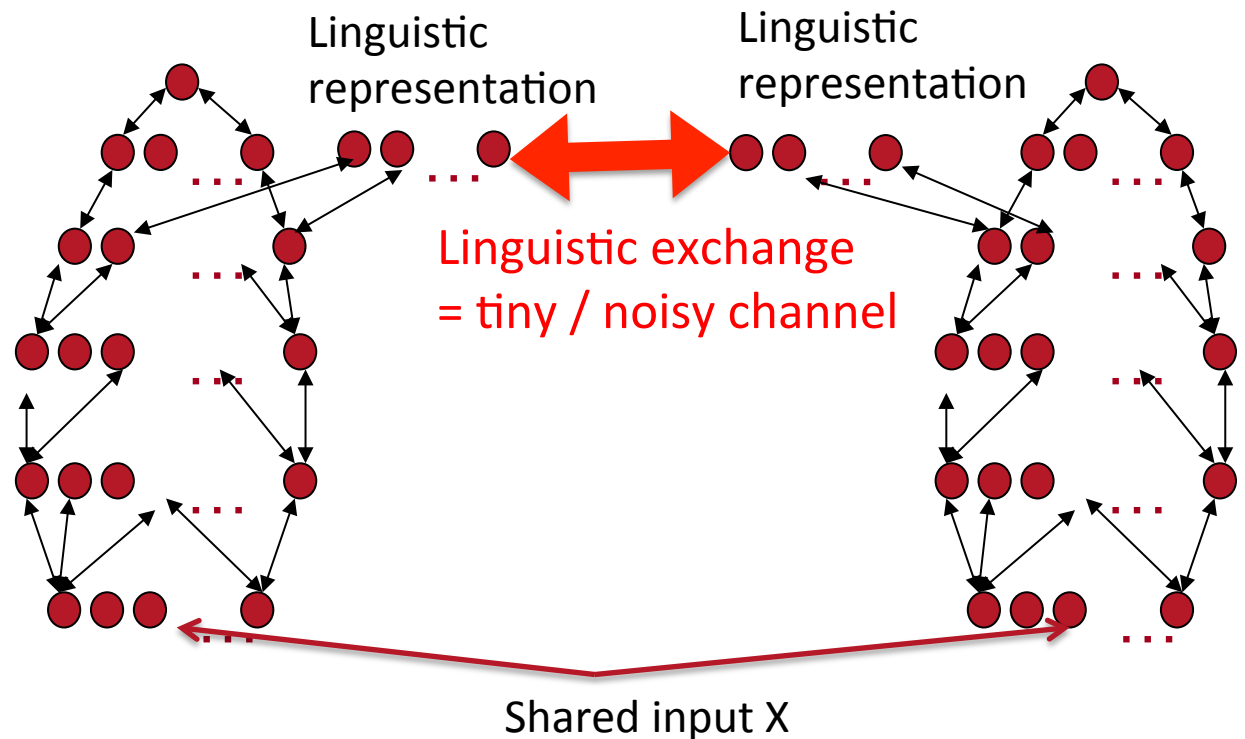
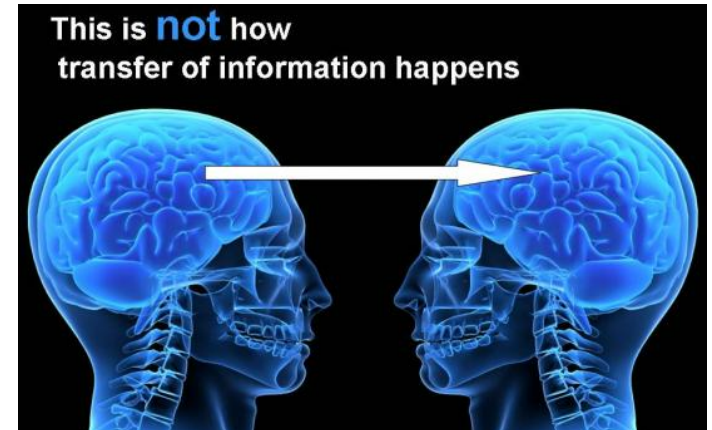

How do we escape local minima?

- linguistic inputs = extra examples, summarize knowledge
- criterion landscape easier to optimize (e.g. curriculum learning)
- turn difficult unsupervised learning into easy supervised learning of intermediate abstractions

How could language/education/culture possibly help find the better local minima associated with more useful abstractions?

More than random search:
potential exponential speed-up by divide-and-conquer
combinatorial advantage:
can combine solutions to independently solved sub-problems

Hypothesis 7

- Language and meme recombination provide an efficient **evolutionary operator**, allowing rapid search in the space of **memes**, that helps humans build up better high-level internal representations of their world.

From where do new ideas emerge?

- Seconds: **inference** (novel explanations for current x)
- Minutes, hours: **learning** (local descent, like current DL)
- Years, centuries: **cultural evolution** (global optimization, recombination of ideas from other humans)

Related Tutorials

- Deep Learning tutorials (python): <http://deeplearning.net/tutorials>
- Stanford deep learning tutorials with simple programming assignments and reading list
<http://deeplearning.stanford.edu/wiki/>
- ACL 2012 Deep Learning for NLP tutorial
<http://www.socher.org/index.php/DeepLearningTutorial/>
- ICML 2012 Representation Learning tutorial
<http://www.iro.umontreal.ca/~bengioy/talks/deep-learning-tutorial-2012.html>
- IPAM 2012 Summer school on Deep Learning
<http://www.iro.umontreal.ca/~bengioy/talks/deep-learning-tutorial-aaai2013.html>
- **More reading: Paper references in separate pdf, on my web page**

Software

- Theano (Python CPU/GPU) mathematical and deep learning library <http://deeplearning.net/software/theano>
 - Can do automatic, symbolic differentiation
- Senna: POS, Chunking, NER, SRL
 - by Collobert et al. <http://ronan.collobert.com/senna/>
 - State-of-the-art performance on many tasks
 - 3500 lines of C, extremely fast and using very little memory
- Torch ML Library (C++ + Lua) <http://www.torch.ch/>
- Recurrent Neural Network Language Model <http://www.fit.vutbr.cz/~imikolov/rnnlm/>
- Recursive Neural Net and RAE models for paraphrase detection, sentiment analysis, relation classification www.socher.org

Software: what's next

- Off-the-shelf SVM packages are useful to researchers from a wide variety of fields (no need to understand RKHS).
- To make deep learning more accessible: release off-the-shelf learning packages that handle hyperparameter optimization, exploiting multi-core or cluster at disposal of user.
 - Spearmint (Snoek)
 - HyperOpt (Bergstra)

Conclusions

- Deep Learning & Representation Learning have matured
 - **Int. Conf. on Learning Representation 2013** a huge success!
- Industrial strength applications in place (Google, Microsoft)
- Room for more research:
 - Scaling computation even more
 - Better optimization
 - Getting rid of intractable inference (in the works!)
 - Coaxing the models into more disentangled abstractions
 - Learning to reason from incrementally added facts

LISA team: **Merci! Questions?**

